

NAVSHIPS 900171

**ELECTRONIC INSTALLATION
PRACTICES MANUAL**

CHAPTER 5

**ELECTRICAL
WIRE CONNECTORS**

BUREAU OF SHIPS

NAVY DEPARTMENT

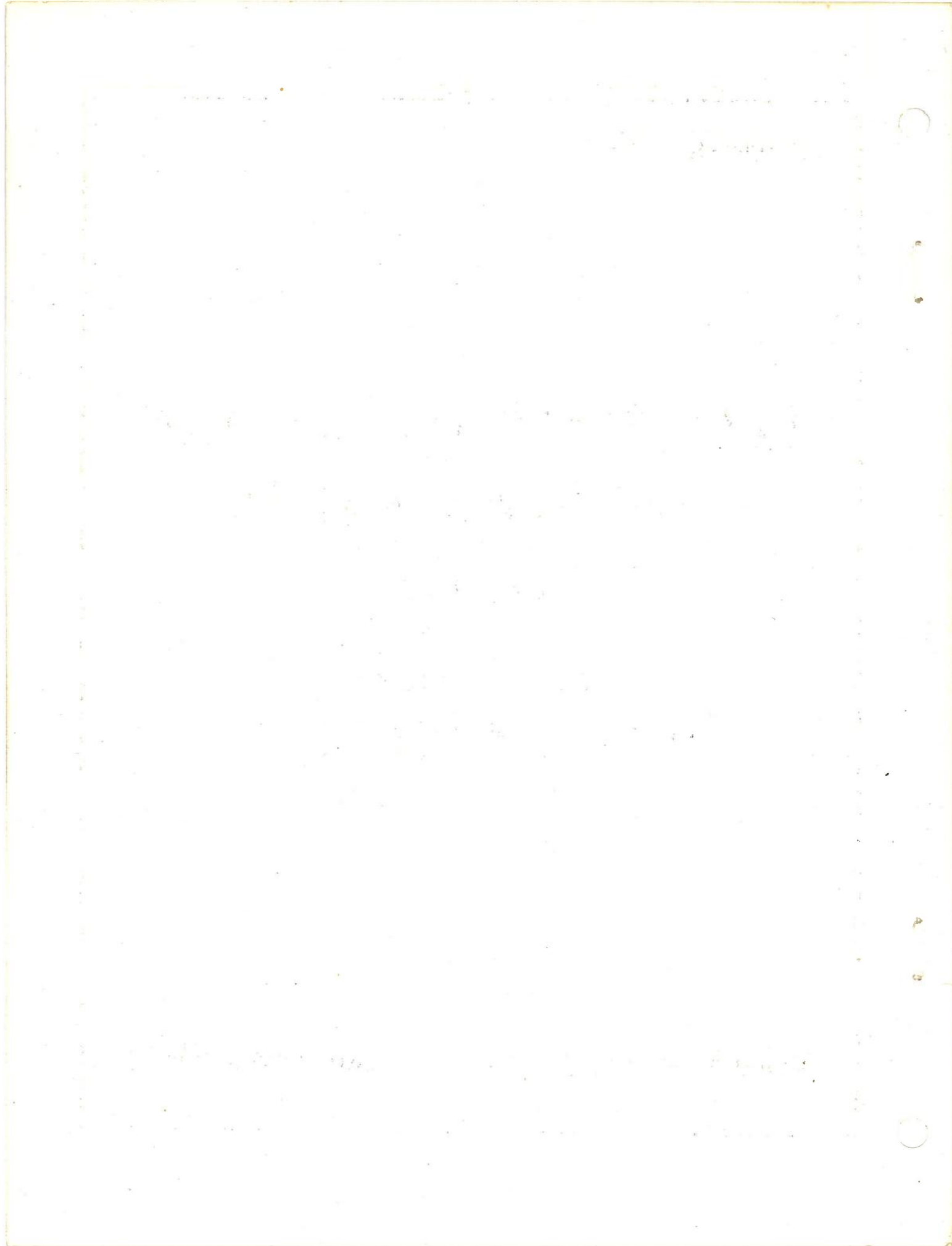

NAVSHIPS 900171

**ELECTRONIC INSTALLATION
PRACTICES MANUAL**

CHAPTER 5

**ELECTRICAL
WIRE CONNECTORS**

BUREAU OF SHIPS

NAVY DEPARTMENT

Page Numbers	Change in Effect	Page Numbers	Change in Effect
Title Page	Original	5-1 to	
A Page	Original	5-73	Original
i to iv	Original	i-1 to i-6	Original

ELECTRONIC INSTALLATION
PRACTICES MANUAL

This manual is intended for the use of the electronic installation worker. It may be used as a reference book on installation practices or in training beginners in Naval electronic installation work.

Subject matter in this text is intended as supplementary to, but not superseding existing and applicable specifications.

Appreciation is extended to the various Naval Shipyards, Commercial Firms, Service Representatives and Manufacturers who were consulted and without whose cooperation this manual would not be possible.

TABLE OF CONTENTS

SECTION 5-1. WIRE TERMINATIONS		SECTION 5-4. "AN" CONNECTORS (Cont'd)	
Paragraph	Page	Paragraph	Page
1. Solder Terminals	5-1	d. Insert	5-11
2. Solderless Terminals	5-1	e. Shell	5-11
3. "AN" Connectors	5-1	f. Polarization	5-11
SECTION 5-2. SOLDER TERMINALS		3. Amphenol Basic Design	5-11
1. Introduction	5-1	4. Cannon Basic Design	5-15
2. Terminal Designation	5-5	5. Bendix Basic Design	5-15
3. Choosing the Terminal Size ...	5-5	6. Types	5-15
4. Connecting and Soldering	5-5	a. AN 3100	5-15
a. General	5-5	b. AN 3101	5-15
b. The Soldering Iron	5-5	c. AN 3102	5-16
c. Preparation of Con- ductors for Soldering	5-7	d. AND 10066	5-16
(1) Enamel Covered	5-7	e. AN 3106	5-16
(2) Stranded Wire	5-8	f. AN 3107	5-16
(3) Litz Wire	5-8	g. AN 3108	5-16
(4) Tinsel Wire	5-8	h. AND 10459	5-17
(5) Types Impregnated with Silicone	5-8	7. Shell Design	5-17
d. Soldering	5-8	8. Connector Designation	5-18
e. Soldering Tubular Terminals	5-9	9. Selecting the Proper Connector	5-19
f. Soldering Perforated Terminals	5-9	a. Insert Required	5-19
g. Soldered Notched or Blank Hook Terminals	5-9	(1) Inserts Available	5-19
h. Connecting at Screw Terminals	5-10	(2) Current Rating	5-19
i. Connecting at Terminal Boards	5-10	(3) Voltage Rating	5-19
SECTION 5-3. SOLDERLESS TERMINALS		(4) Insert Selection	5-19
1. General	5-10	(5) Contact Type	5-39
SECTION 5-4. "AN" CONNECTORS		b. Choosing the Shell Size ...	5-39
1. Introduction	5-11	c. Connector Part Number ...	5-39
2. Basic Design	5-11	d. Insert Selection Example ...	5-39
a. Contact	5-11	10. Special Connector Notes	5-45
(1) Pin	5-11	a. Alternate Position Inserts .	5-45
(2) Socket	5-11	b. Thermocouple Connectors .	5-46
b. Receptacle	5-11	c. Automatic Grounding and Short-Circuiting Connectors	5-46
c. Plug	5-11	d. Jones Plugs and Sockets ...	5-47
		11. Installation	5-47
		a. Soldering to the Connectors	5-47
		b. Strain Relief Bar	5-51
		c. Method of Terminating Armored Cable and Shields at "AN" Connectors	5-52
		d. Clamp for Unarmored Cables	5-55
		e. Safety Wiring	5-56
		f. General Installation Hints..	5-56

LIST OF ILLUSTRATIONS

SECTION 5-2. SOLDER TERMINALS		SECTION 5-4. "AN" CONNECTORS (Cont'd)	
Figure	Page	Figure	Page
5-1	Stamped Type Solder Lug Terminals	5-2	
5-2	Perforated, Notched and Miscellaneous Type Terminals	5-3	
5-3	Spade Lugs and Grid Caps	5-5	
5-4	Soldering Iron Tip Shapes	5-7	
5-5	Enamel Removing Tool Made from Hacksaw Blade	5-7	
5-6	Terminating Tinsel Wire . . .	5-8	
5-7	Soldering Tubular Terminal	5-9	
5-8	Soldering Perforated Terminal	5-9	
5-9	Soldering Notched or Blank Hook Terminals	5-9	
SECTION 5-3. SOLDERLESS TERMINALS			
5-10	WT and WTG Solderless Terminal Types	5-10	
SECTION 5-4 "AN" CONNECTORS			
5-11	Basic Design of Amphenol "AN" Connectors	5-12	
5-12	Basic Design of Cannon "AN" Connectors	5-13	
5-13	Basic Design of Bendix "AN" Connectors	5-14	
5-14	Wall Mounting Receptacle	5-15	
5-15	Cable Mounting Receptacle	5-15	
5-16	Box Mounting Receptacle	5-16	
5-17	Integral Mounting Receptacle	5-16	
5-18	Straight Plug	5-16	
5-19	Straight Quick Disconnect Plug	5-16	
5-20	Right Angle Plug	5-17	
5-21	Integral Mounting Plug	5-17	
5-22	AN Designation from MIL-C-5015	5-18	
5-23	"AN" Insert Contact Arrangements- 1 Contact	5-20	
5-24	"AN" Insert Contact Arrangements- 2 Contact	5-21	
5-25	"AN" Insert Contact Arrangements- 3 Contact	5-22	
5-26	"AN" Insert Contact Arrangements- 4 Contact	5-23	
5-27	"AN" Insert Contact Arrangements- 5 Contact	5-24	
5-28	"AN" Insert Contact Arrangements- 6 Contact	5-25	
5-29	"AN" Insert Contact Arrangements- 7 Contact	5-26	
5-30	"AN" Insert Contact Arrangements- 8 Contact	5-27	
5-31	"AN" Insert Contact Arrangements- 9 Contact	5-28	

SECTION 5-4. "AN" CONNECTORS (Cont'd)	
Figure	Page
5-32 "AN" Insert Contact Arrangements- 10 and 11 Contact	5-29
5-33 "AN" Insert Contact Arrangements- 12 and 13 Contact	5-30
5-34 "AN" Insert Contact Arrangements- 14 Contact	5-31
5-35 "AN" Insert Contact Arrangements- 15 and 16 Contact	5-32
5-36 "AN" Insert Contact Arrangements- 17, 19, and 20 Contact	5-33
5-37 "AN" Insert Contact Arrangements- 22 and 23 Contact	5-34
5-38 "AN" Insert Contact Arrangements- 24, 25 and 26 Contact	5-35
5-39 "AN" Insert Contact Arrangements- 29 and 30 Contact	5-36
5-40 "AN" Insert Contact Arrangements- 31 and 35 Contact	5-37
5-41 "AN" Insert Contact Arrangements- 37, 41 and 42 Contact	5-38
5-42 "AN" Insert Contact Arrangements- 47 and 48 Contact	5-38
5-43 Alternate Position Inserts ..	5-45
5-44 Automatic Grounding and Short-Circuiting Connectors	5-46
5-45 Jones Plug and Socket Assembly	5-47
5-46 Pre-Tinning Conductors	5-48
5-47 Soldering Cables to Contacts	5-49
5-48 Tying Conductors with String	5-50
5-49 Soldering to Large Removable Contacts	5-50
5-50 Position of Locking Rings	5-51
5-51 Strain Relief Bar	5-51

SECTION 5-4. "AN" CONNECTORS (Cont'd)	
Figure	Page
5-52 Terminating Cable Armor at "AN" Connectors	5-53
5-53 Alternate Method of Grounding Armor at "AN" Connectors	5-54
5-54 Use of Cable Clamp AN 3057	5-55
5-55 Strap Wrench	5-56
5-56 Amphenol AN 3100A Solid Shell Wall Receptacle	5-58
5-57 Amphenol AN 3100B Split Shell Wall Receptacle	5-58
5-58 Amphenol AN 3100K Shielded Receptacle	5-60
5-59 Amphenol AN 3101A Solid Shell Cable Receptacle	5-61
5-60 Amphenol AN 3101B Split Shell Cable Receptacle	5-62
5-61 Amphenol AN 3102A Solid Shell Box Receptacle	5-63
5-62 Amphenol AN 3106A Solid Shell Straight Plug	5-64
5-63 Amphenol AN 3106B Split Shell Straight Plug	5-65
5-64 Amphenol AN 3106K Straight Plug	5-66
5-65 Amphenol AN 3108A Solid Shell Angle Plug	5-67
5-66 Amphenol AN 3108B Split Shell Angle Plug	5-68
5-67 Bendix AN 3101A Cable Connecting Assembly	5-69
5-68 Bendix AN 3102A Box Mounting Receptacle Assembly	5-70
5-69 Bendix AN 3106A Straight Plug Assembly	5-71
5-70 Bendix AN 3106M Type M Connector	5-72
5-71 Bendix AN 3108A 90-degree Plug Assembly ..	5-73

LIST OF TABLES

SECTION 5-2. SOLDER TERMINALS		SECTION 5-4. "AN" CONNECTORS (Cont'd)	
Table	Page	Table	Page
5-1 Solder Lug Terminal- Punched Tube Type	5-4	5-5 Insert Specifications (22-16 to 24-28)	5-42
5-2 Electrical Connector Size Designation	5-6	5-6 Insert Specifications (28-1 to 32-12)	5-43
SECTION 5-4. "AN" CONNECTORS		5-7 Insert Specifications (32-13 to 48-1)	5-44
5-3 Insert Specifications (8S-1 to 18-19)	5-39	5-8 AN 3057 Cable Clamp Data	5-52
5-4 Insert Specifications (18-20 to 22-15)	5-40	5-9 Coupling Thread Size for Various "AN" Shell Sizes	5-57

SECTION 5-1

WIRE TERMINATIONS

This chapter discusses, in order, the three major groups of electrical connections as used in electronic installations. In these three groups, wire termination is a persistent electrical problem. No matter what the form of application, the quality of wire terminations must be excellent. These three major groups are as follows:

1. SOLDER TERMINALS.

Solder terminals are widely used in electronic work. When properly made they are strong, permanent connections. However, there is always the danger of a "cold solder joint" and of corrosion from soldering fluxes unless care is used. Acid fluxes should never be used.

Soldering to various types of terminals is discussed in Section 5-2.

2. SOLDERLESS TERMINALS.

For some applications in electronic work, the use of an approved solderless terminal has been authorized. Some of

the considerations that make up a good solderless connection are as follows: identical and uniform connections, insulation support, low resistance, radio noise interference free, and corrosion proofing. Solderless terminals are discussed in Section 5-3.

3. "AN" CONNECTORS.

"AN" connectors are sometimes used for power indicating and control circuits of shipboard electronic equipment. They provide means of making dependable connections in water-proof, moisture-proof, flame-proof, vibration-proof, and pressure-proof applications. A complete "AN" connector is made up of two mating units, a plug assembly and a receptacle assembly.

The "AN" prefix in connector part numbers indicates that design, materials and construction conform to the military specification MIL-C-5015. "AN" connectors are discussed in Section 5-4.

SECTION 5-2

SOLDER TERMINALS

1. INTRODUCTION.

Soldered connections are widely used in electronic installations to make a permanent and dependable connection. Among the various types of solder connectors are the following:

The stamped, perforated, notched, tubular, semi-tubular, screw, wire loop (Figures 5-1 and 5-2) and punched tube types (Table 5-1). These are available with one or two bolt holes, square,

round or other tongue ends, and miscellaneous shapes and notch arrangements. The two bolt hole type is used where there is a possibility of twisting the terminal. The cable ends should be prepared for the terminal connection by trimming back the insulation for the required distance and thoroughly cleaning the wire strands. In some types the terminal is clamped over the prepared conductor so as to provide a solid mechanical connection before soldering.

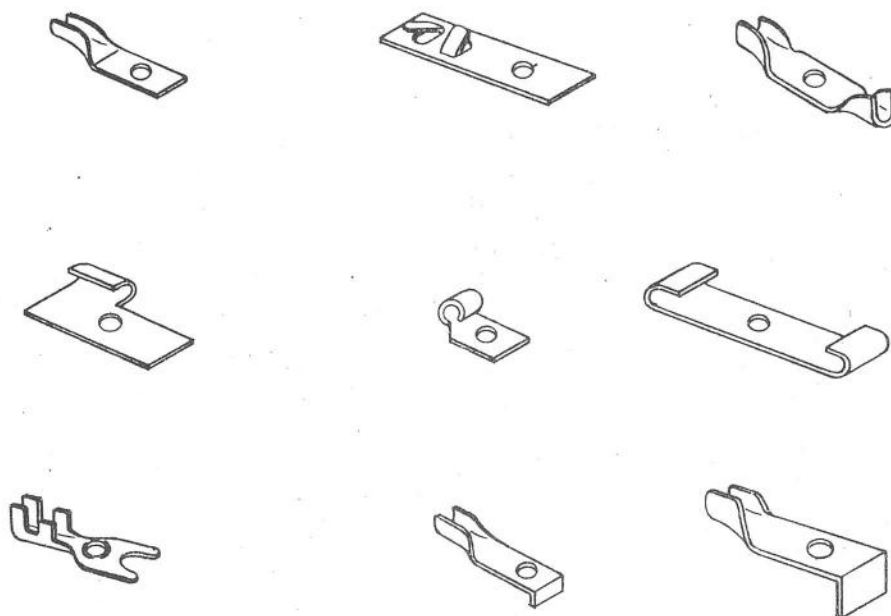

ONE BOLT HOLE, SQUARE TONGUE END



ONE BOLT HOLE, ROUND TONGUE END



TWO BOLT HOLE, SQUARE TONGUE END

Figure 5-1. Stamped Type Solder Lug Terminals



PERFORATED TERMINALS

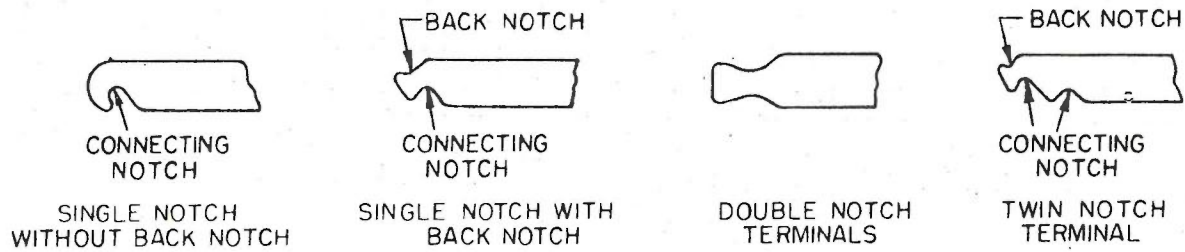

NOTCHED TERMINALS

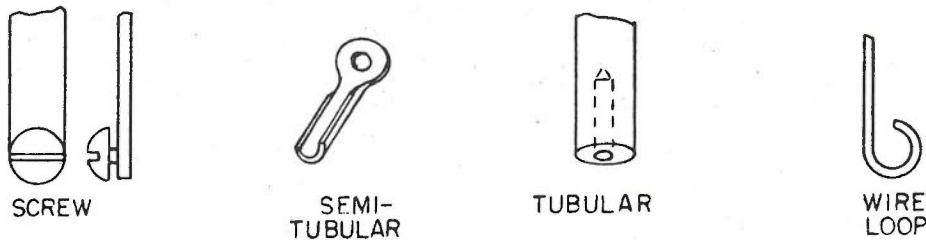

MISCELLANEOUS TERMINALS

Figure 5-2. Perforated, Notched and Miscellaneous Type Terminals

TABLE 5-1. SOLDER LUG TERMINAL - PUNCHED TUBE TYPE

Stock No.	Lug No.	Cable			Lug				
		Circular Mils	Amps (Max)	Outside Diam Copper Inches	A (In.)	B (In.)	C (In.)	D (In.)	E (In.)
G17-L-14325	PT1	4,000	15	0.076	0.136	3/16	15/16	17/64	9/64
G17-L-14328	PT2	9,000	30	.108	.187	1/4	1-1/32	23/64	3/16
G17-L-14331	PT3	14,000	40	.136	.232	5/16	1-1/32	7/16	3/16
G17-L-14333	PT3	23,000	53	.171					
G17-L-14334	PT4	30,000	64	.201	.285	3/8	1-11/32	17/32	9/32
	PT4	40,000	73	.226					
G17-L-14337	PT5	50,000	85	.254	.336	7/16	1-1/2	5/8	9/32
G17-L-14340	PT6	60,000	96	.282	.398	1/2	3/4	23/32	11/32
G17-L-14343	PT7	75,000	132	.317	.461	9/16	1-31/32	13/16	13/32
G17-L-14346	PT8	100,000	156	.363	.511	5/8	2-1/8	29/32	13/32

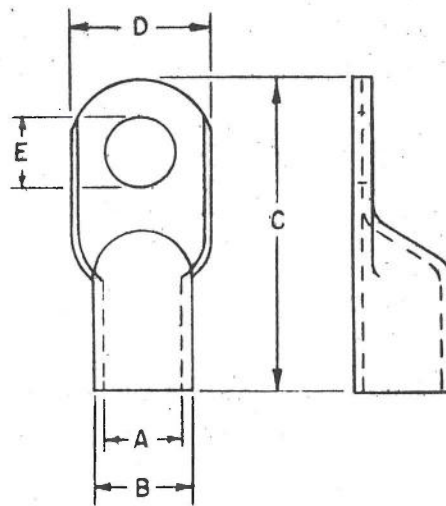

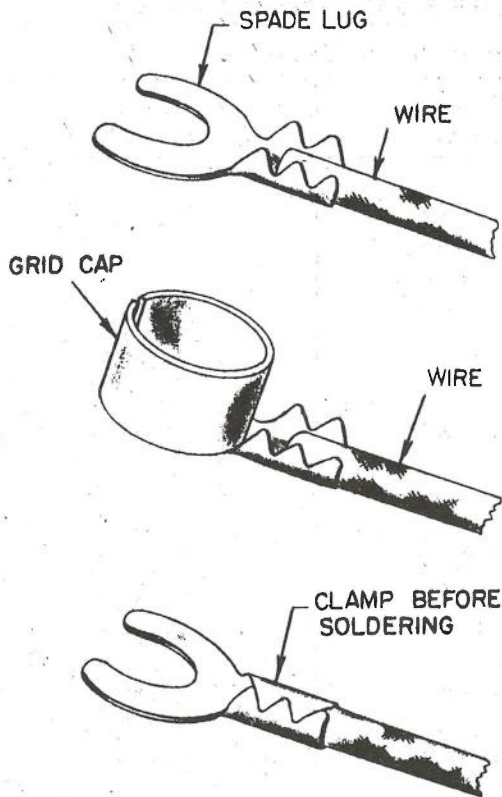

Figure 5-3. Spade Lugs and Grid Caps

The spade lug and the grid cap (Figure 5-3) are examples of this.

2. TERMINAL DESIGNATION.

The electrical connectors, terminal lugs and lugs used by the Navy are usually identified as to size by means of a number stamped or molded on their surface. This number indicates the standard Navy cable size or sizes with which the connector, terminal, or lug is designed to be used. In cases where the connector fits more than one cable size, the range of sizes is stamped on the connector. For example: If the numbers "1-2" were to appear on a connector, it could be used with standard Navy cable sizes from 1 (1) up to and including 2 (7) as shown in Table 5-2. This table also gives the circular mil area and the diameter in inches over the copper corresponding to the various standard Navy cable sizes.

ORIGINAL

3. CHOOSING THE TERMINAL SIZE.

Before choosing the size of terminal needed for a certain job, the following should be known:

- a. The size of wire on which the terminal is to be used.
- b. The tongue shape needed (ring, slotted, spade tip, rectangular, flag, etc.).
- c. The stud size needed.
- d. The terminal dimensions, stud clearance, tongue widths, etc.

After deciding on the type and shape, use Table 5-2 to determine the size.

4. CONNECTING AND SOLDERING.

a. GENERAL. - Solder alone should never be depended upon to make the mechanical connection. Before soldering, make sure that the connection is mechanically secure. Details on how this is done are covered under the terminal types, but in general, long nose pliers are used to wrap bared conductors around the terminals or to crimp spade type terminals. The connecting and soldering operation may be divided into three parts:

- (1) Preparing the wire and terminal.
- (2) Connecting the wire to the terminal.
- (3) Applying heat and solder to the wire and terminal.

b. THE SOLDERING IRON. - The 100 watt soldering iron is the size most widely used for electronic work. The tips are usually made of copper and are replaceable. Continued heating of the soldering iron causes the tip to oxidize. The copper tip becomes coated with an oxide scale which retards the transfer of heat from the heating element to the tip and makes it necessary to remove the tip periodically for cleaning purposes.

Since heat transfer is more efficient from a bright, tinned surface, a soldering iron tip must be carefully tinned before using. The procedure for tinning a tip is as follows:

TABLE 5-2. ELECTRICAL CONNECTORS SIZE DESIGNATION

Size No.	For Standard Navy Cable		
	Size Designation	Size (Cir Mil)	Diam Over Copper (In.)
1/5-1	1/5 (1) -26	254	0.0159
	1/5 (7) -26	280	.0162
	2/5 (1) -24	404	.020
	2/5 (7) -24	442	.025
	1/2 (21)	525	.028
	3/5 (1)	642	.025
	3/5 (7)	700	.030
	1 (1)	1,022	.032
1-2	1 (1)	1,022	.032
	1 (7)	1,020	.039
	1 (10)	1,005	.038
	1-1/2 (1)	1,624	.040
	1-1/2 (7)	1,624	.049
	1-1/2 (16)	1,608	.049
	1-1/2 (41)	1,630	.049
	2 (7)	1,779	.048
2-1/2-5	2-1/2 (1)	2,585	.051
	2-1/2 (19)	2,407	.060
	2-1/2 (26)	2,613	.061
	3 (7)	2,828	.060
	4 (1)	4,107	.064
	4 (7)	4,497	.076
	4 (19)	3,828	.072
	4 (41)	4,121	.077
6-9	6 (7)	6,512	.092
	6 (19)	6,088	.090
	9 (7)	9,030	.109
	9 (37)	9,402	.109
14	14 (7)	14,340	.136
	14 (140)	14,070	.145
23	23 (7)	22,800	.171
30	30 (19)	30,860	.202
40	40 (19)	38,910	.226
50	50 (19)	49,080	.254

(1) While the iron is cold, file the soldering surface of the tip with a fine cut file until they are clean and smooth.

(2) Heat the iron. When it is hot enough to melt solder, rub sandpaper or steel wool lightly over the soldering surfaces of the tip.

(3) Apply rosin-core solder to the tip immediately after cleaning.

(4) After a few seconds, remove the excess solder with a clean cloth so that a thin, uniform film of solder is formed on the tip. Be sure that the cloth is folded a sufficient number of times to prevent a burn from the hot iron.

The soldering iron tip should be shaped for the job. Figure 5-4 shows three shapes which are in wide use. The pointed and the blunt tips are general purpose types used for soldering leads to terminals and connectors. The chisel

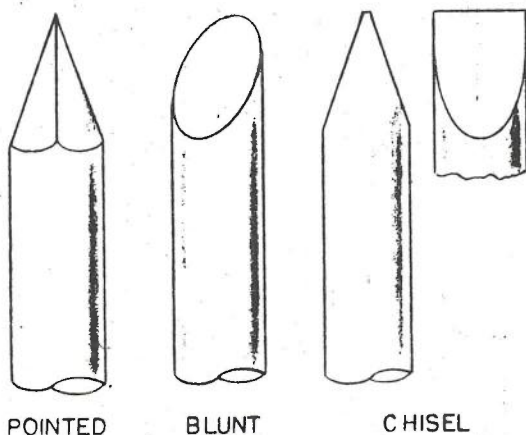

Figure 5-4. Soldering Iron Tip Shapes

tip is used for soldering to the terminals of multipin connectors, such as "AN" connectors.

c. PREPARATION OF CONDUCTORS FOR SOLDERING. - Solder will not adhere to a surface unless it is clean; therefore, all dirt and grease should be removed from the terminal by cleaning with alcohol or carbon tetrachloride before soldering to it. Rosin flux is the only type used in electronic work to remove oxides and to prevent oxidation while soldering, thus enabling the solder

to form a more perfect bond. Rosin core solder is composed of 50% tin and 50% lead (5 lb spool; SNSN G46-S-905) and is widely used in the Navy. There are acid fluxes which are more powerful than rosin flux; however, the danger of corrosion prohibits their use in electronic work.

After the terminal has been cleaned, strip the insulation from the end of the wire. Diagonals or wire strippers (See Chapter 3, Hand Tools) may be used to strip insulation. When diagonals are used, avoid nicking the conductor. After removing the correct length of insulation, keep the stripped conductor clean and avoid contact with dirt and grease. Some types of conductors require special treatment as follows:

(1) ENAMEL COVERED. - Enamel must be completely removed from the portion of the wire to be soldered. Burning the enamel by applying heat from a torch or large size iron will aid in removing the enamel. A strip of No. 00 sandpaper may be folded over as in a book match cover and passed over the enameled conductor so that it lies between the folds and faces the abrasive surface. Draw out the wire and repeat until the enamel is removed.

A useful tool for removing enamel can also be made from an old hacksaw blade, as shown in Figure 5-5.

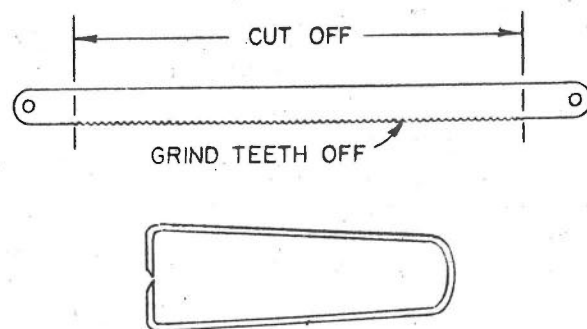

NOTE
IF NECESSARY,
HEAT TO BEND

Figure 5-5. Enamel Removing Tool
Made from Old Hacksaw Blade

(2) STRANDED WIRE. - If stranded wire is not clean, spread the strands out for cleaning and tin the strands. Wipe off excess solder and twist the tinned strands together again.

(3) LITZ WIRE. - Litz wire is made up of a large number of strands of fine wire insulated from each other except at the ends where the various strands are connected in parallel and twisted to form one conductor. It is widely used in RF coils below 2 megacycles. Before soldering this wire, the enamel must be removed from each strand. A fine sandpaper (No. 00) may be used for this purpose, but extreme care must be taken so that no strands are broken. The strands are twisted together and tinned after the enamel is removed.



REMOVE $\frac{1}{2}$ " OF INSULATION

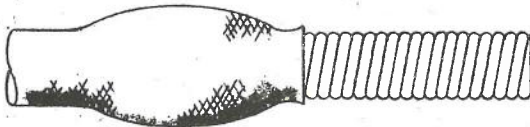

PUSH BACK INSULATION ANOTHER $\frac{1}{2}$ "
AND SERVE EXPOSED TINSEL WIRE
WITH NO. 34 BARE COPPER WIRE



MOVE INSULATION BACK TO ORIGINAL POSITION



SERVE INSULATION WITH CORD.
TIN EXPOSED END.

Figure 5-6. Terminating Tinsel Wire

(4) TINSEL WIRE. - This is a very flexible wire widely used for phone cords. Before soldering, the tinsel wire is served with No. 34 bare copper wire. Figure 5-6 shows the four steps in doing this. Avoid using too hot an iron to prevent damage to the silk core.

(5) TYPES IMPREGNATED WITH SILICONE. - The reduced diameter cable types have a water-proofing compound (silicone grease) which fills all voids even in individual conductors. This grease makes the soldering of terminals very difficult. Individual strands must be cleaned with "Decaline" (Deca-Hydro-Napthalene, a solvent for silicone grease). To use, first remove excess grease by wiping. Then apply the solvent and wipe clean.

d. SOLDERING. - Tin the terminal and the conductor by applying heat with a clean iron immediately after cleaning and allowing a small amount of solder to melt in contact with the terminal or conductor. Shake or wipe off excess solder before it hardens.

Before soldering the wire to the terminal, make sure that there is a good mechanical connection.

Heat the terminal with a soldering iron and apply solder to the terminal and not to the iron. The solder will melt on contact if the terminal is at the proper temperature. If the terminal is not heated sufficiently and solder is applied by melting it on the iron, the hot solder will cool upon contact with the terminal and will not bond to it properly, thus forming a "cold solder" joint which may eventually oxidize or loosen.

A good hot solder joint has a smooth, shiny, hard surface.

A cold solder joint has a dull, irregular, rough surface. A cold solder joint can be corrected by reapplying the hot iron to the joint until the solder melts and then carefully removing the iron, the solder should solidify with a bright, smooth finish.

Allow enough solder to flow so that the connection is completely covered, but

avoid excessive solder. When removing the iron, use care not to move the connection until the solder has hardened. Remove excess rosin flux with carbon tetrachloride. Check to see that no solder protrudes from the connection and remove all loose solder particles.

e. **SOLDERING TUBULAR TERMINALS.** - Because of the construction of tubular terminals, the strength of the connection comes from the solder well and the conductor is not mechanically secured to the terminal before soldering as outlined below.

(1) Heat the terminal and fill the tube or well with solder.

(2) Hold wire at edge of hole and reheat terminal as shown in Figure 5-7.

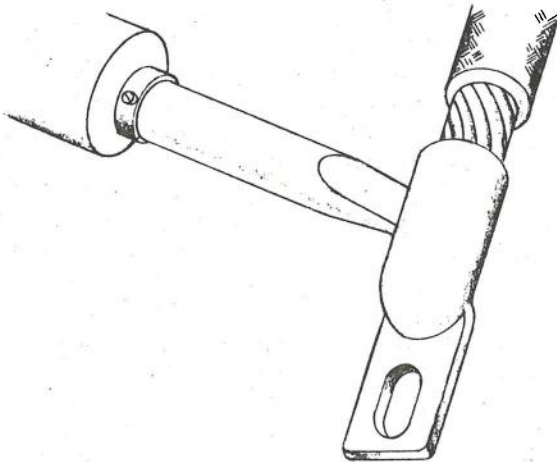

Figure 5-7. Soldering Tubular Terminal

(3) Insert wire in tube and at the same time move tip back toward base of terminal.

(4) Withdraw wire to see if it is properly tinned. If so, reinsert wire and remove iron. Wire must be held steady while solder cools.

The length of skinned wire should be slightly less than the depth of terminal, to permit insulation to be brought up close to terminal.

Appearance should be neat and clean. Clean off all flux residue and frayed insulation.

ORIGINAL

f. **SOLDERING PERFORATED TERMINALS.** - Secure the conductor to the terminal mechanically by forming a hook on the conductor and crimping it on the terminal with long nose pliers. (Figure 5-8.) Heat the connection be-

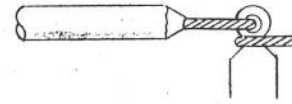

Figure 5-8. Soldering Perforated Terminal

for applying solder. When temperature of the connection has been raised above the melting point of solder, apply solder alongside the stripped wire, and melt enough solder to completely cover the wire. Hold the iron tip on the connection until the solder has flowed completely around the wire and filled the hole in the terminal. Withdraw the iron tip along the wire and over the end of the terminal. Avoid excessive solder. Cut off the excess wire with diagonal cutters. The wire should not extend beyond the end of the terminal by more than 1/16 inch.

g. **SOLDERING NOTCHED OR BLANK HOOK TERMINALS.** - Secure the conductor to the terminal mechanically by forming a hook on the conductor and wrapping the conductor around the terminal with long nose pliers. (Figure 5-9.) Follow the same procedure as outlined above for perforated terminals. Make certain that solder flows around and under the wire.

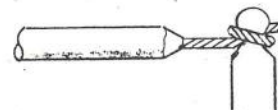
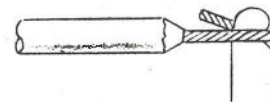

Figure 5-9. Soldering Notched or Blank Hook Terminals

h. CONNECTING AT SCREW TERMINALS. Loosen screws as far as possible without disengaging. Connect the wire with one complete turn around the screw in a clockwise direction. If more than one wire is to be connected, twist the bare portions together before placing on the screw. If stranded wire is used, twist and solder the ends first. Use long nose pliers to wrap the wire on the screw. Cut off excess wire and tuck the end under the washer or the screw head.

i. CONNECTING AT TERMINAL BOARDS. - The sequence of operations

in connecting to a terminal board is as follows:

- (1) Prepare the conductors.
- (2) Connect to the terminals.
- (3) Solder.
- (4) Test.

Since perforated, notched, blank hook or screw terminals are commonly used on terminal boards, the above instructions apply when preparing, connecting and soldering. Testing is done by ringing through. Care should be used in forming conductors neatly and breaking off from a laced cable properly. This is pointed out in Chapter 9 (CABLING).

SECTION 5-3

SOLDERLESS TERMINALS

1. GENERAL.

At the present time, solderless terminals are not approved for electronics installation, except for some special applications. Therefore, it is impossible to discuss solderless terminals and tooling in detail. However, a few general facts can be discussed.

Solderless terminals must conform to Military Specification MIL-E-16366.

For use on wire sizes of 4500 circular mils and below, types WT and WTG are specified.

Type WTG terminals are identical to type WT terminals except that they include an insulation grip or shroud forming a part of the barrel to clamp over the insulation of the conductor and are a closed end terminal for water sealing purposes. Size designation is the same as discussed in Section 5-2. Some of the types available are shown in Figure 5-10.

It should be emphasized that these types require the use of a special crimping tool. The most common source of trouble in solderless terminal applications is caused by the use of an improper crimping tool. Never use diagonal cutters to crimp a solderless terminal, always use the prescribed tool. In using the tool, take time to complete the crimping cycle. Some tools are equipped with ratchets on the handles which

will not reopen until the crimping cycle is completed. This insures a uniform and complete crimp. Care should be taken in stripping insulation to avoid loss of conductor strands. The loss of strands may result in reduced tensile strength and a loose connection. If the insulation frays during stripping, fold back the frayed edges to prevent the insulation from entering the barrel where the crimping is done. Never tin the conductors that are to be terminated with solderless terminals. Remember that even when installed with the most extreme care and with the proper tooling, solderless terminations are inferior to soldered terminations for most electronic applications. Take time and care to do a good job.

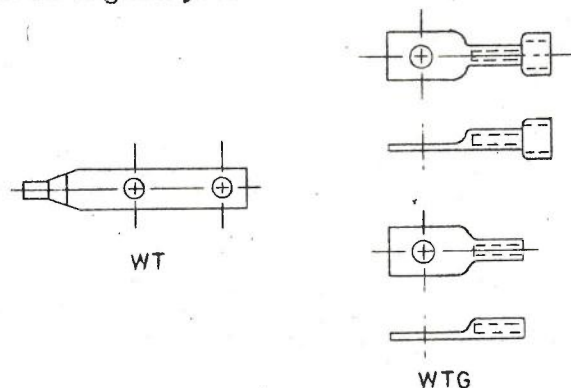

Figure 5-10. WT and WTG Solderless Terminal Types

SECTION 5-4

"AN" CONNECTORS

1. INTRODUCTION.

AN connectors provide a detachable connection in one or more electrical circuits. A complete AN connector consists of two mating units - a plug assembly and receptacle assembly. Within the plug and receptacle are contacts through which the electrical circuits are made. These electrical connector assemblies provide a convenient means for connecting and disconnecting electrical circuits. Size and weight have been held to a minimum.

AN connectors are primarily for use in critical aeronautical electrical circuits, to make and hold electrical circuits securely and without objectionable voltage drop under conditions of extreme vibrations and rapid changes in temperature and altitude. However, they are widely used in shipboard electronic equipment and a description of the basic types and installation method will be helpful to the installation worker.

2. BASIC DESIGN.

The following parts go into the basic design of an AN connector:

a. CONTACT. - The contact is the immediate part used in joining together single conductors. The complete contact assembly consists of a pin and its socket.

(1) PIN. - The pin is that part of the contact assembly which is inserted into its mating part (socket). The pin is normally connected to the "dead" side of the circuit.

(2) SOCKET. - The socket is that part of the contact assembly which receives its mating part (pin). The socket is normally connected to the "live" side of the circuit.

b. RECEPTACLE. - The receptacle is the part of a complete connector assembly which is normally "fixed", that is, rigidly attached to or is an integral part of a supporting surface. It is threaded for mating with the coupling ring which is a part of the mating plug. It may be provided with either pin or socket contacts. The receptacle is made from aluminum alloy.

c. PLUG. - The plug is that part of an electrical connector assembly which is normally removable after disengagement of the threaded coupling. It mounts the free turning coupling ring and may be provided with either socket or pin contacts.

d. INSERT. - The insert is that part of the assembly which holds the contacts in their proper arrangement and electrically insulates them from each other and from other parts. Insert material may be phenolic, melamine, ceramic, or other high dielectric material.

e. SHELL. - The outside case of the assembly into which the insert and contact are assembled is known as the shell. It is made from aluminum alloy.

f. POLARIZATION. - The proper angular positioning of the plug with respect to the receptacle is known as polarization. It is done by means of an internal polarizing key in the receptacle shell and a polarizing slot in the plug shell.

3. AMPHENOL BASIC DESIGN.

The exploded view (Figure 5-11) shows the basic design of Amphenol "AN" connectors. Insert and contacts are designed so that the contacts cannot rotate when assembled. The inserts and contact assembly is held securely in the shell by a spring retainer ring. This

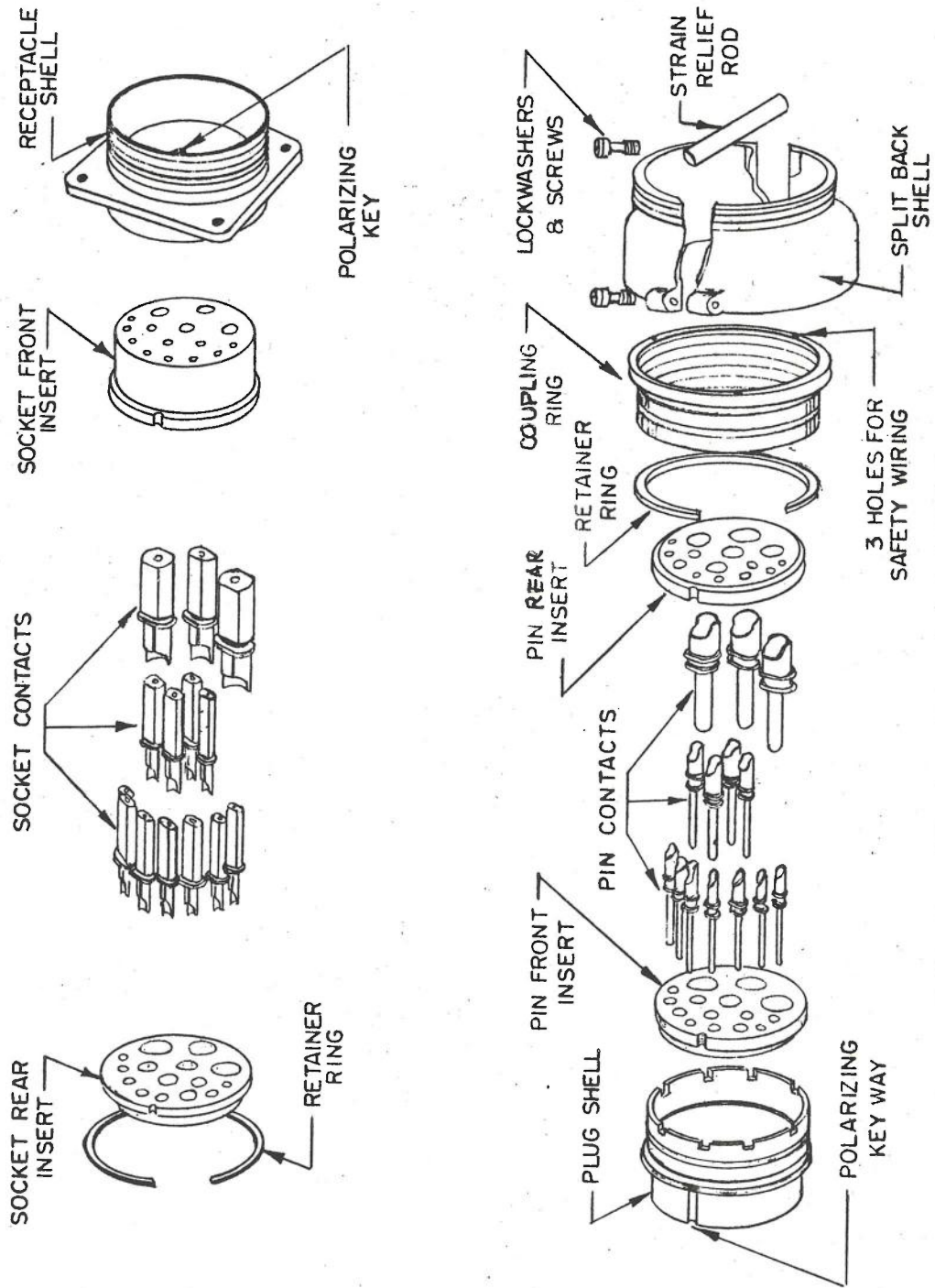
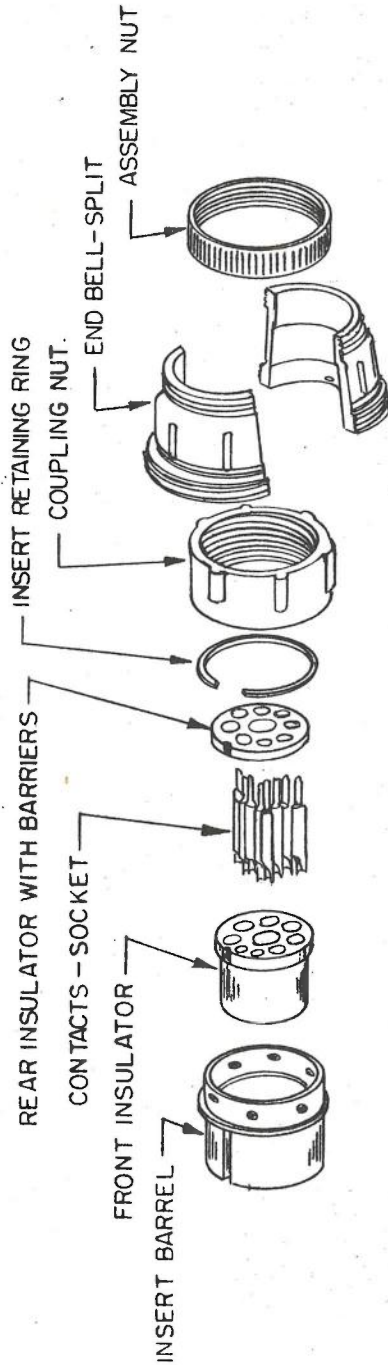
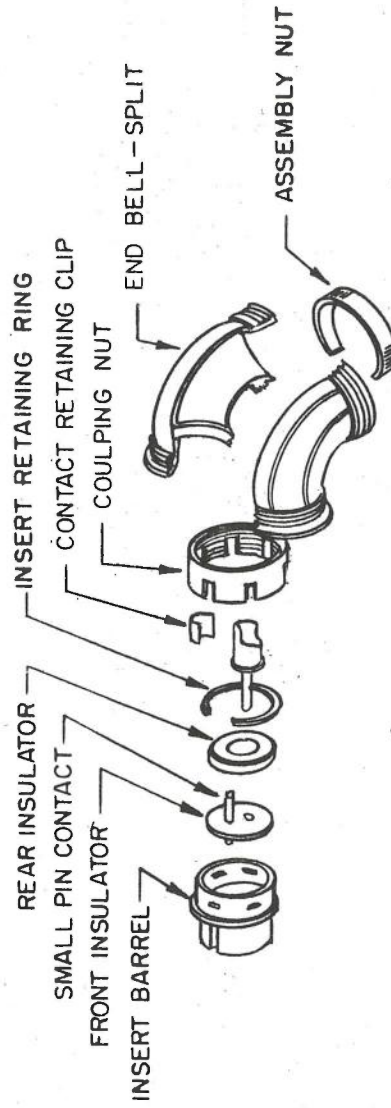

Figure 5-11. Basic Design of Amphenol "AN" Connectors



AN 3106B PIN INSERT ASSEMBLY (PLUG)



AN 3108B SOCKET INSERT ASSEMBLY (RECEPTACLE)

Figure 5-12. Basic Design of Cannon "AN" Connectors

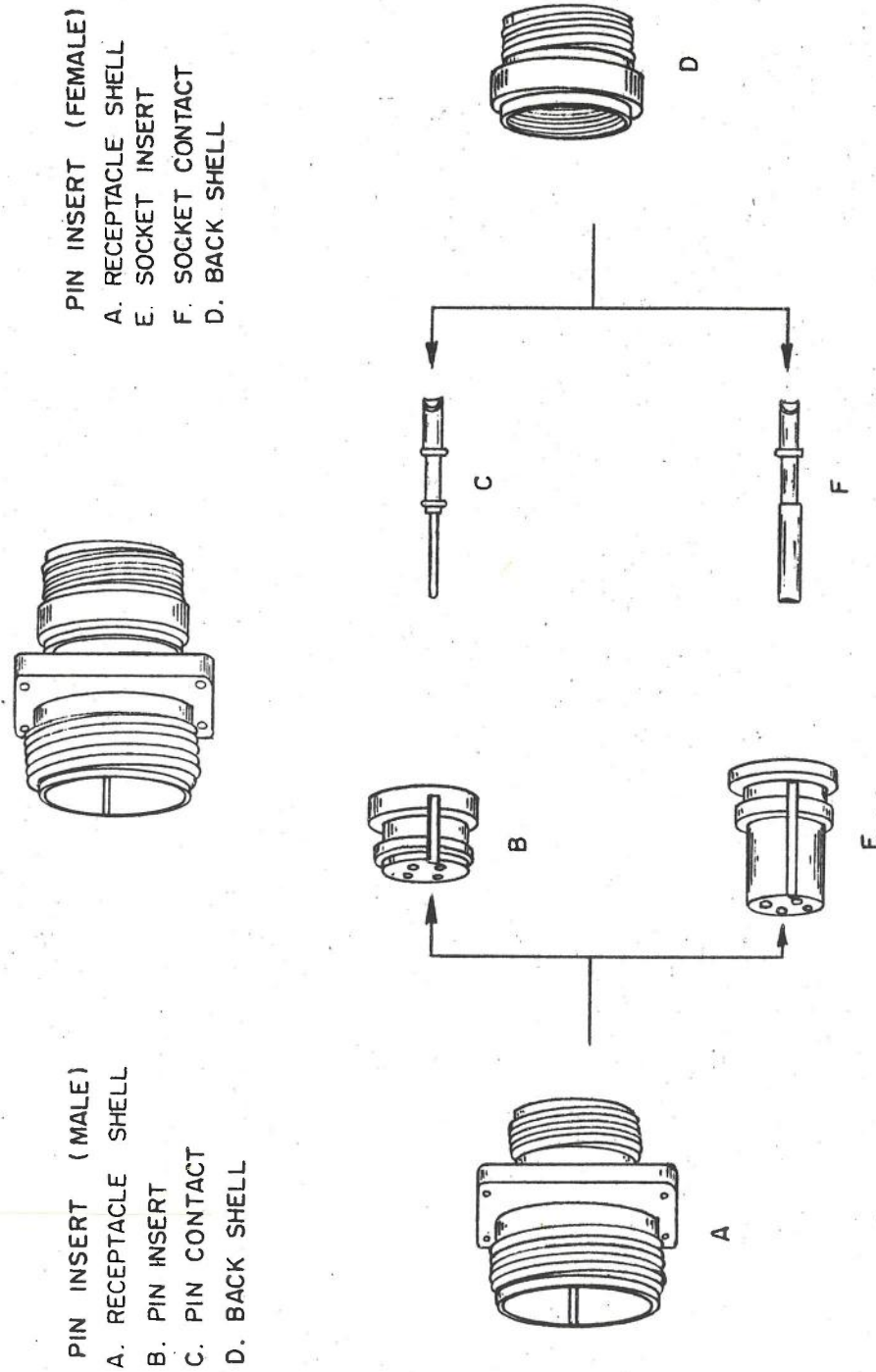

Figure 5-13. Basic Design of Bendix "AN" Connectors

ring is installed or removed with a small screwdriver. A slot on the end of the shell allows easy removal of the ring. Pin contacts and socket contacts with their respective inserts are interchangeable in all "AN" shell designs. Note that the complete insert assembly consists of two parts; the front insert and the rear insert. Each contact is identified by a letter molded on both the front and rear insert parts.

4. CANNON BASIC DESIGN.

The exploded view (Figure 5-12) shows the basic design of Cannon "AN" connectors. The contacts can be rotated in the inserts. The insert assemblies of shell size 14 and larger are held in the shell with a spring retainer ring. Pin contacts and socket contacts with their respective inserts are interchangeable in all shells. Note that the complete insert consists of two parts; the front insulator and the rear insulator. Connector shells for normal use have sand blast and tin plate finish or sand blast with clear lacquer finish.

5. BENDIX BASIC DESIGN.

The basic design of Bendix "AN" connectors is shown in Figure 5-13. Note the one piece insert and the lack of a retaining ring. The inserts snap into place in the shell under pressure. The contacts are snapped into the insert from either end. Either pin or socket contacts with their respective inserts may be used in all shells. The standard finish is cadmium plate.

6. TYPES.

The basic types are as follows:
 Receptacle Connector Assemblies
 AN 3100 --- Wall Mounting
 AN 3101 --- Cable Connecting
 AN 3102 --- Box Mounting
 AND 10066 - Integral Mounting

Plug Connector Assemblies
 AN 3106 --- Straight
 AN 3107 --- Quick Disconnect
 AN 3108 --- Angle 90°
 AND 10459 - Integral Mounting

Regardless of the use, the receptacle always has the shell with the external threads, and the plug has the shell with the loose coupling rings. These basic types are shown in Figures 5-14 through 5-21. The following is a more detailed description of the basic types. Later, it will be seen that the basic types are available with solid shell design, split shell design or special purpose design depending upon the application.

a. AN 3100.- AN 3100 is a receptacle for wall or bulkhead use. It has an internal polarizing key and is threaded on the back for coupling to conduit.

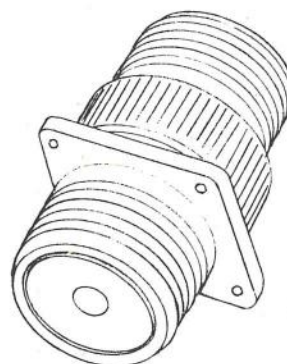

AN 3100 A
SOLID SHELL

Figure 5-14. Wall Mounting Receptacle

b. AN 3101.- AN 3101 is a cable receptacle. It allows a detachable splice connection in cable or conduit. The front shell contains an internal polarizing key and the back shell is threaded for coupling to conduit or cable clamp.

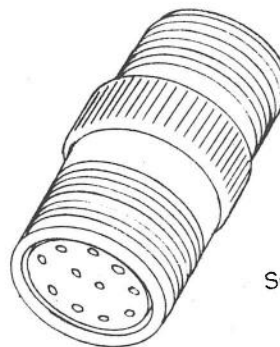

AN 3101 A
SOLID SHELL

Figure 5-15. Cable Mounting Receptacle

c. AN 3102.- AN 3102 is a box receptacle which mounts directly on equipment, chassis or panel. It differs from AN 3100 in that it has open terminals on the back and is not threaded for conduit coupling. It has an internal polarizing key.

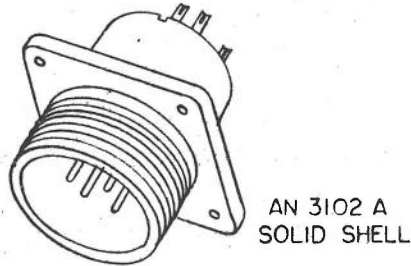

Figure 5-16. Box Mounting Receptacle

d. AND 10066.- AND 10066 is an integral mounting receptacle intended for use where the shell of the receptacle can be made as an integral part of the electrical equipment housing.

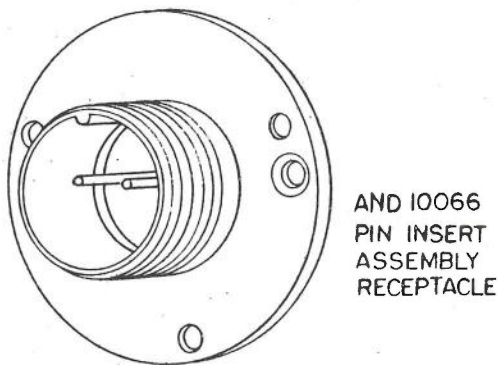

Figure 17. Integral Mounting Receptacle

e. AN 3106.- AN 3106 is a straight plug. The front shell has a polarizing slot for engaging with the polarizing key in all types of AN receptacles. It can be attached directly to cable or conduit. It has a coupling ring on the front shell and the back shell is threaded to the couple conduit or cable clamps. The back shell is removable for wiring and inspection.

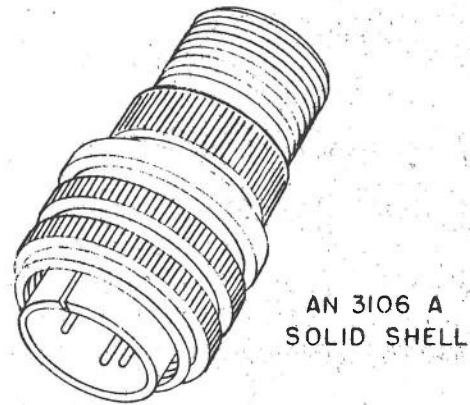

Figure 5-18. Straight Plug

f. AN 3107.- AN 3107 is a quick disconnect plug, intended for use where extremely rapid disconnection is essential for emergency conditions or reasons of safety. However, they are not adaptable to vibration conditions. The front shell has a polarizing slot. The plug may be disconnected from its receptacle by applying axial tension between the plug and the receptacle.

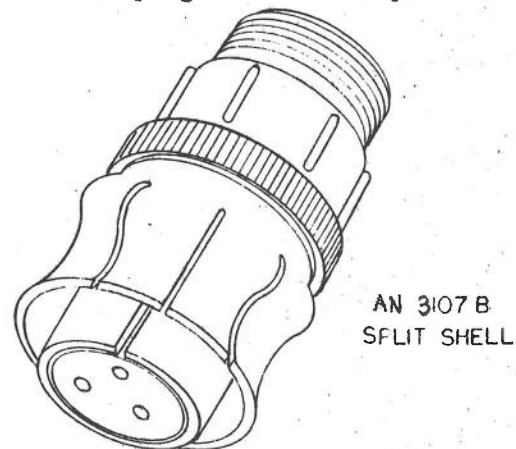
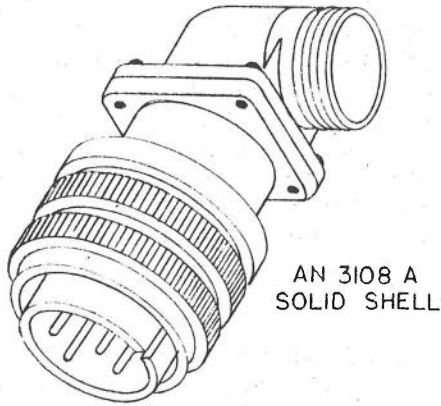

Figure 5-19. Straight Quick Disconnect Plug

g. AN 3108.- AN 3108 is a right angle plug which is attached directly to cable or conduit. As in AN 3106, the front shell has a polarizing slot and a knurled coupling ring and the back shell is threaded to couple conduit or cable clamps. It is intended for use where available space for the plug is limited.



AN 3108 A
SOLID SHELL

Figure 5-20. Right Angle Plug

h. AND 10459.- AND 10459 is an integral mounting plug intended for use where the shell of the plug can be made an integral part of the electrical equipment housing. The structure behind the barrel is not defined in the specifications and may be designed to meet the specific requirements.

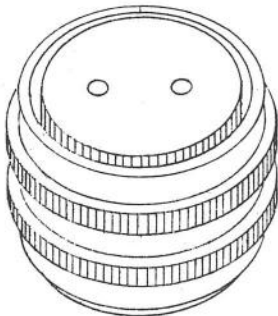

AND 10459
PIN INSERT
ASSEMBLY

Figure 5-21. Integral Mounting Plug

7. SHELL DESIGN.

The letter "A" is used to indicate that the connector is of the solid shell design and meets the standard performance requirements of MIL-C-5015. The solid shell design gives strength, space conservation, and some degree of protection from weather.

The letter "B" indicates that the connector is of the longitudinally split shell design and meets the standard performance requirements of MIL-C-5015.

This design gives convenience in soldering and inspection of wiring. One or both halves of the back shell are removed by loosening the assembly screws.

The following are special purpose:

The letter "C" indicates special purpose connector for pressurized applications. It provides a pressure-tight feed-through for circuits passing through equipment walls or bulkheads.

The assembly contacts, inserts, and shells prevent leakage of more than one cubic inch of air per hour when subjected to pressure differential of 30 pounds per square inch.

The letter "D" indicates a connector which is used for air tight applications. Its construction is such that it is pressurized to a lesser degree than the "pressurized" connectors.

The letter "F" indicates a vibration resistant connector, intended for use in applications subject to continuous vibration or acceleration. Either solder cups or solderless type contacts are used.

The letter "H" indicates a flame barrier connector, intended for use to prevent the passage of flame through a fire barrier in locations liable to fire. It is not required that the electrical circuit be maintained.

The letter "K" indicates a fireproof connector, intended for use wherever it is necessary to maintain continuity of electrical service for a limited time even though the connector is subject to continuing flame. Solder cups are not used.

The letter "L" indicates a waterproof connector intended for use wherever it is necessary to maintain circuit continuity of electrical service when subjected to excessive moisture conditions.

The letter "M" indicates a moisture-proof connector intended for use where condensation resulting from rapid changes of altitude, temperature and humidity must not affect the insulation

resistance or lower the breakdown voltage. They are of the solid shell design and constructed to positively hold the dielectric in position. A circumferential and longitudinal compression is provided on a backing grommet.

The connection is furnished complete with all parts or subassemblies, including the proper backing grommet and cable clamp adapter. They also conform to the requirements for pressurized connectors.

8. CONNECTOR DESIGNATION.

The AN connector series includes thousands of combinations, but the

marking system allows easy and accurate identification. Refer to Figure 5-22 where AN 3100A-16-11P is given as an example. The designation of AN connectors is established by specification MIL-C-5015. Note that there are six parts in identifying a connector. When other than standard insert positions and finishes are specified, two more parts may be added. Each complete connector assembly is permanently marked on the shell.

AN.—The AN prefix indicates an Army-Navy approved type and one that meets the requirements of specification MIL-C-5015.

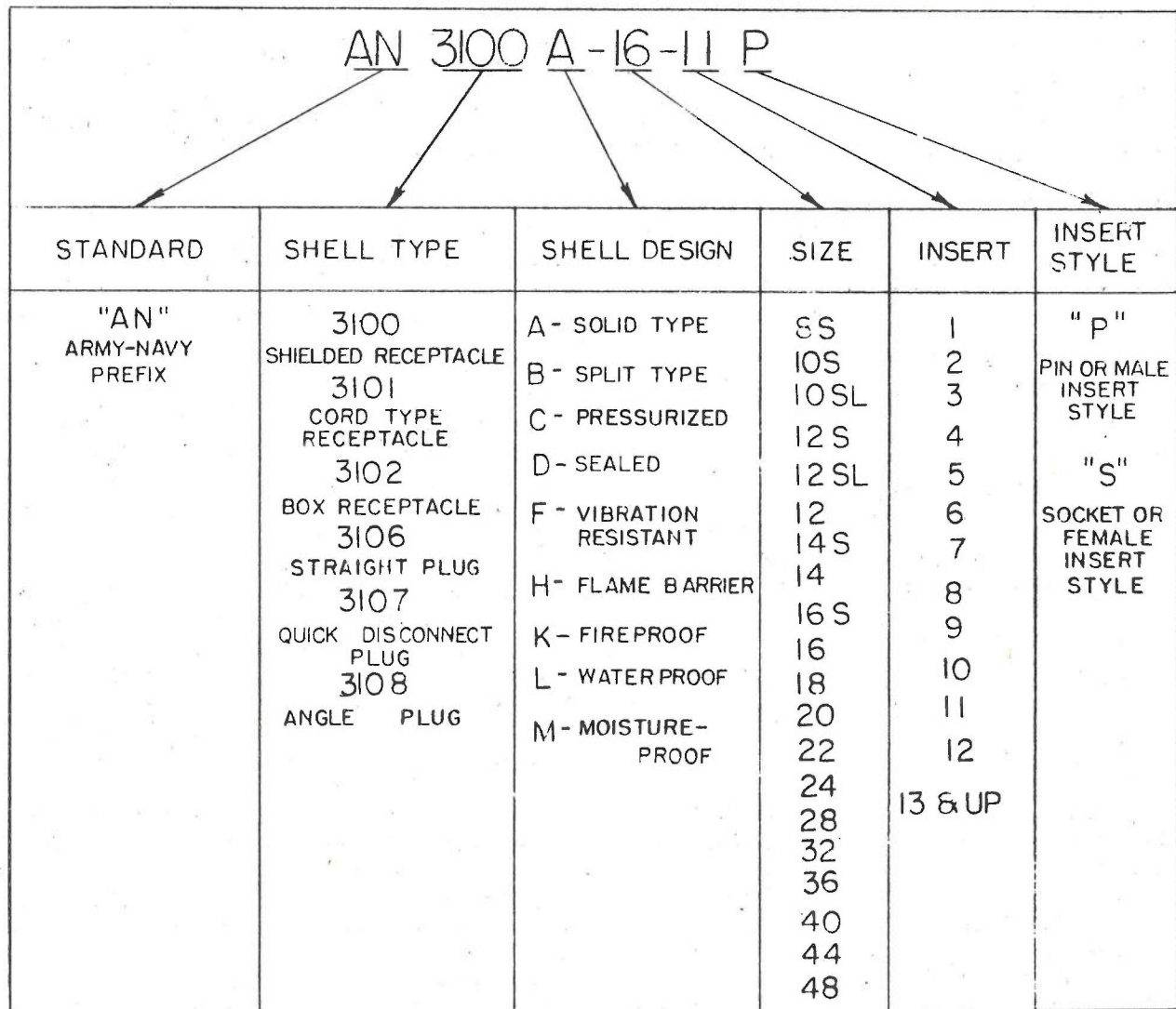

Figure 5-22. AN Designation from MIL-C-5015

3100. - This number indicates one of the basic types as mentioned above. In this case it indicates a wall mounting receptacle.

A. - This letter indicates the shell design. The service conditions to be met determine which design is to be used.

16. - This number indicates the shell size. The diameter of the connector is approximately equal to the shell size figure multiplied by 1/16 inch. Sometimes a suffix s is added to the shell sizes (example 8s). This indicates a connector slightly shorter, but in all other respects the same.

11. - This number indicates the insert arrangement. Specified insert arrangements are always identified with the shell size figure as well as this figure, (example: 16-11). There are many variations of contact layout, but this number does not necessarily indicate the number of contacts in a connector.

These numbers are the same for all mating connectors.

P. - This letter indicates a pin contact. S indicates a socket contact. All connectors are made so that either may be used.

9. SELECTING THE PROPER CONNECTOR.

There are two basic considerations when selecting a connector for an application; determining the insert required and determining the shell style.

a. INSERT REQUIRED.

(1) INSERTS AVAILABLE. - First determine the number of contacts needed and find the inserts available having the necessary number of contacts. These may be found in "AN Insert Contact Arrangements", Figures 5-23 through 5-42.

(2) CURRENT RATING. - Determine the current rating required for each contact. The size of the contacts and

their spacing in the insert determine current and voltage ratings.

Notice in Figures 5-23 through 5-42 that inserts are listed by the number of contacts and, to the right of each arrangement, the number of contacts of each AWG wire size is listed. Designation of the contacts is based upon the AWG size of conductor normally used with each contact. The contacts are drawn to a code so that contact size may be determined from the layout. The following chart gives the current rating for the various contact sizes:

CURRENT RATING

Contact Size	20	16	12	8	4	0
Amperes	10	20	35	60	110	200

(3) VOLTAGE RATING. - Determine the working voltage required for each contact. Notice below the contact size listing is a single letter. This letter is the voltage service rating as indicated on the chart below.

SERVICE INSTRUMENT (Inst)

Max Operating Voltage DC	Inst	A	D	E	B	C
	70	200	500	650	750	3000
At Sea Level AC (RMS)	50	150	275	350	500	2100

INST service is normally for low voltages and currents. "A" service is normally for use on 28-volt power supply.

(4) INSERT SELECTION. - Knowing these requirements, look through all the available insert arrangements listed under the number of contacts needed and choose the one that most suits the purpose. Be on the safe side, never over-rate the connector. It may sometimes be necessary to use a connector having spare contacts in order to get one to do the job. Notice that immediately under each insert arrangement are two numbers. These two numbers identify the shell and insert arrangement and must be used together.

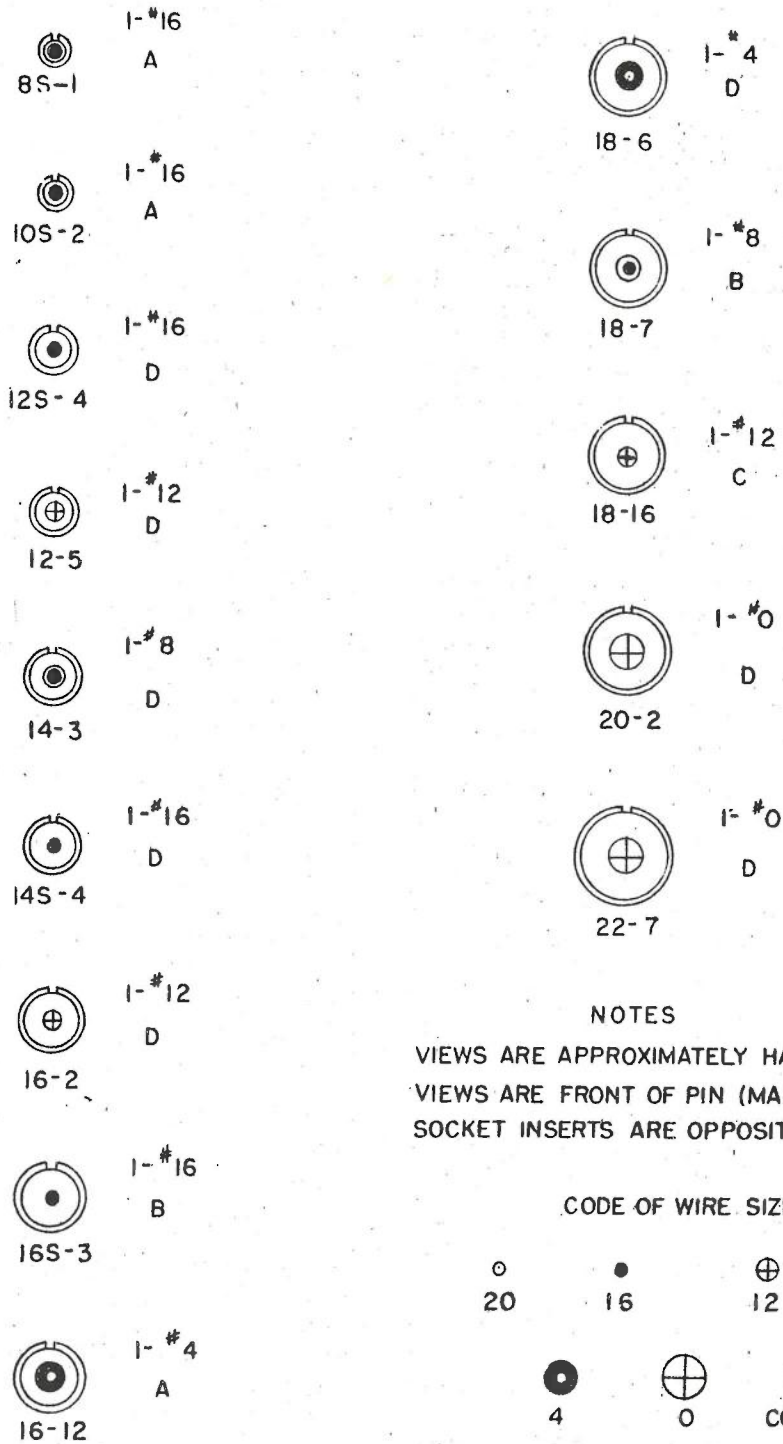

NOTES

VIEWS ARE APPROXIMATELY HALF SIZE.
VIEWS ARE FRONT OF PIN (MALE) INSERTS.
SOCKET INSERTS ARE OPPOSITE

CODE OF WIRE SIZES

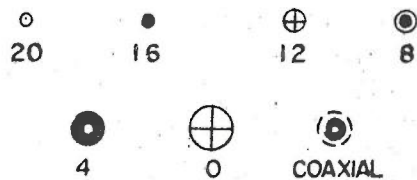

Figure 5-23. "AN" Insert Contact Arrangements - 1 Contact

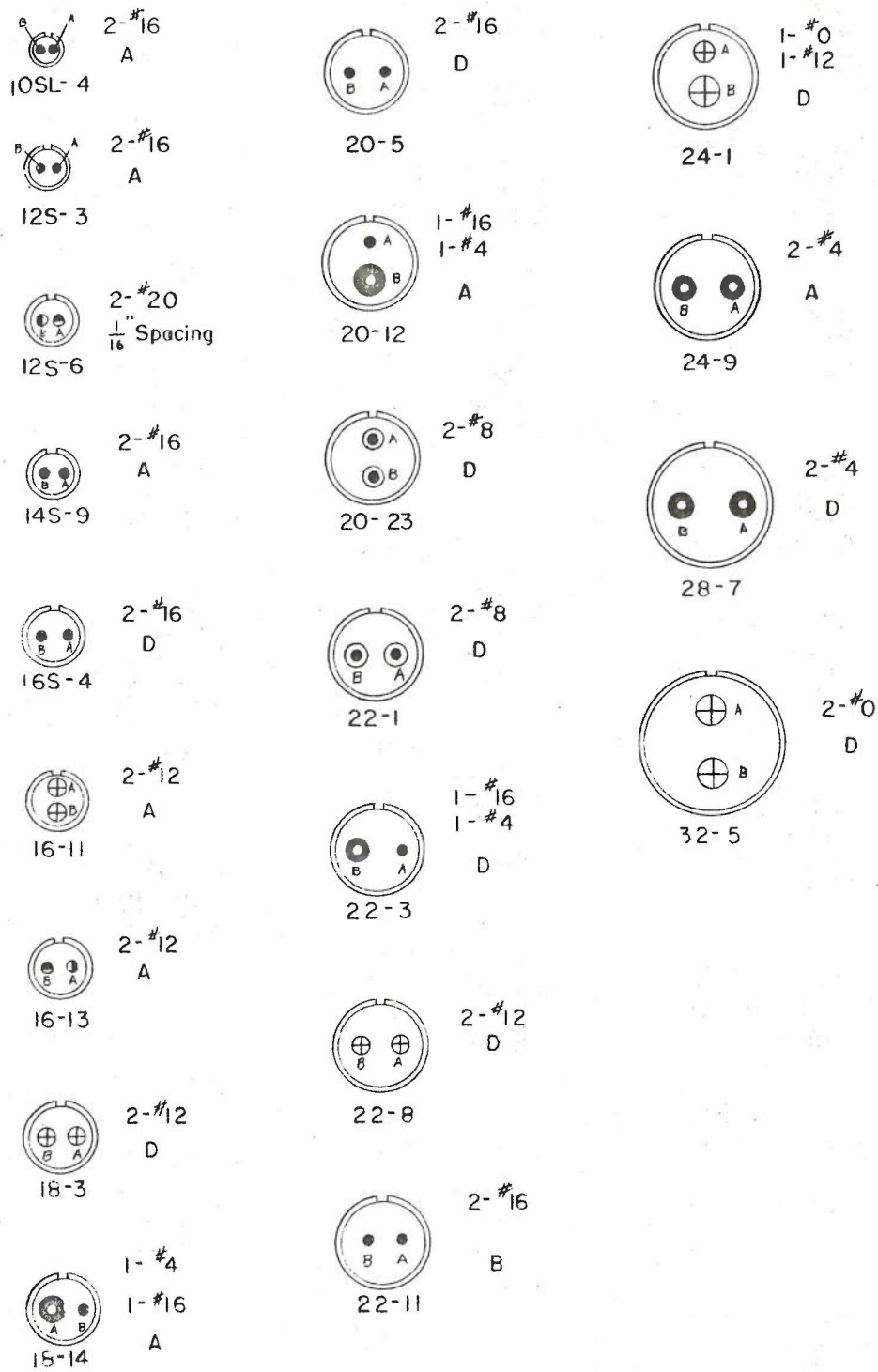

Figure 5-24. "AN" Insert Contact Arrangements- 2 Contact

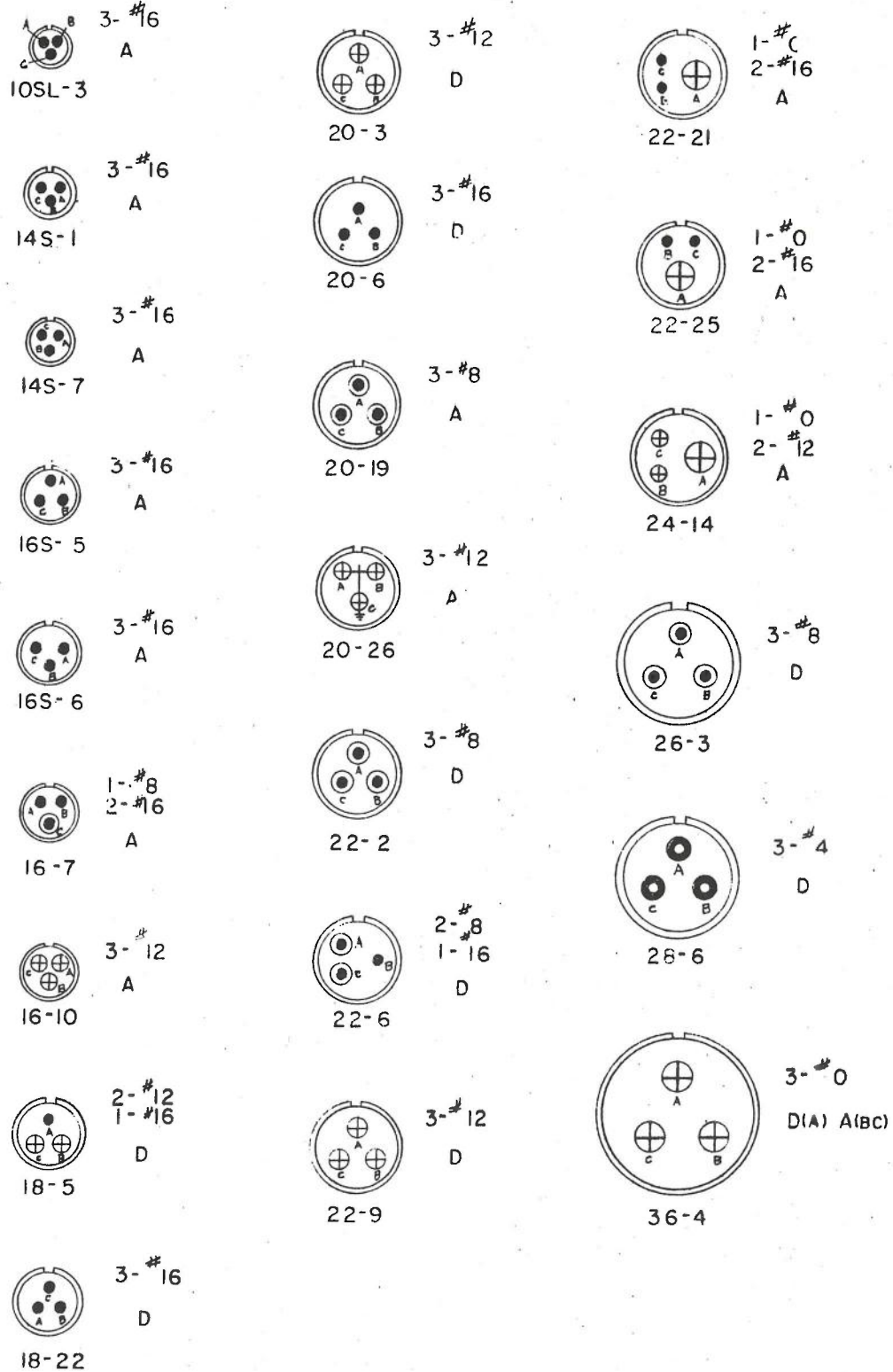

Figure 5-25. "AN" Insert Contact Arrangements - 3 Contact

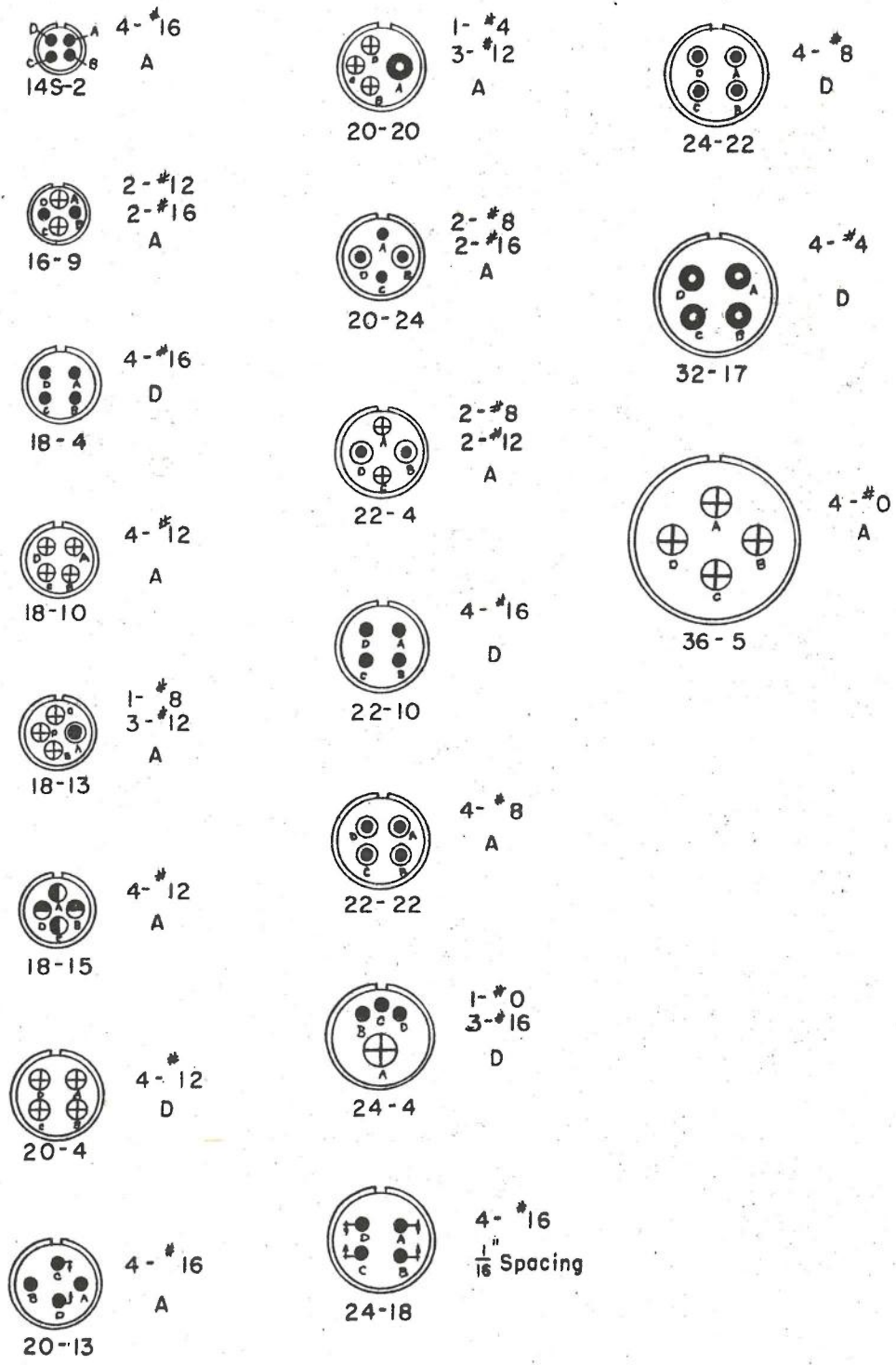

Figure 5-26. "AN" Insert Contact Arrangements - 4 Contact

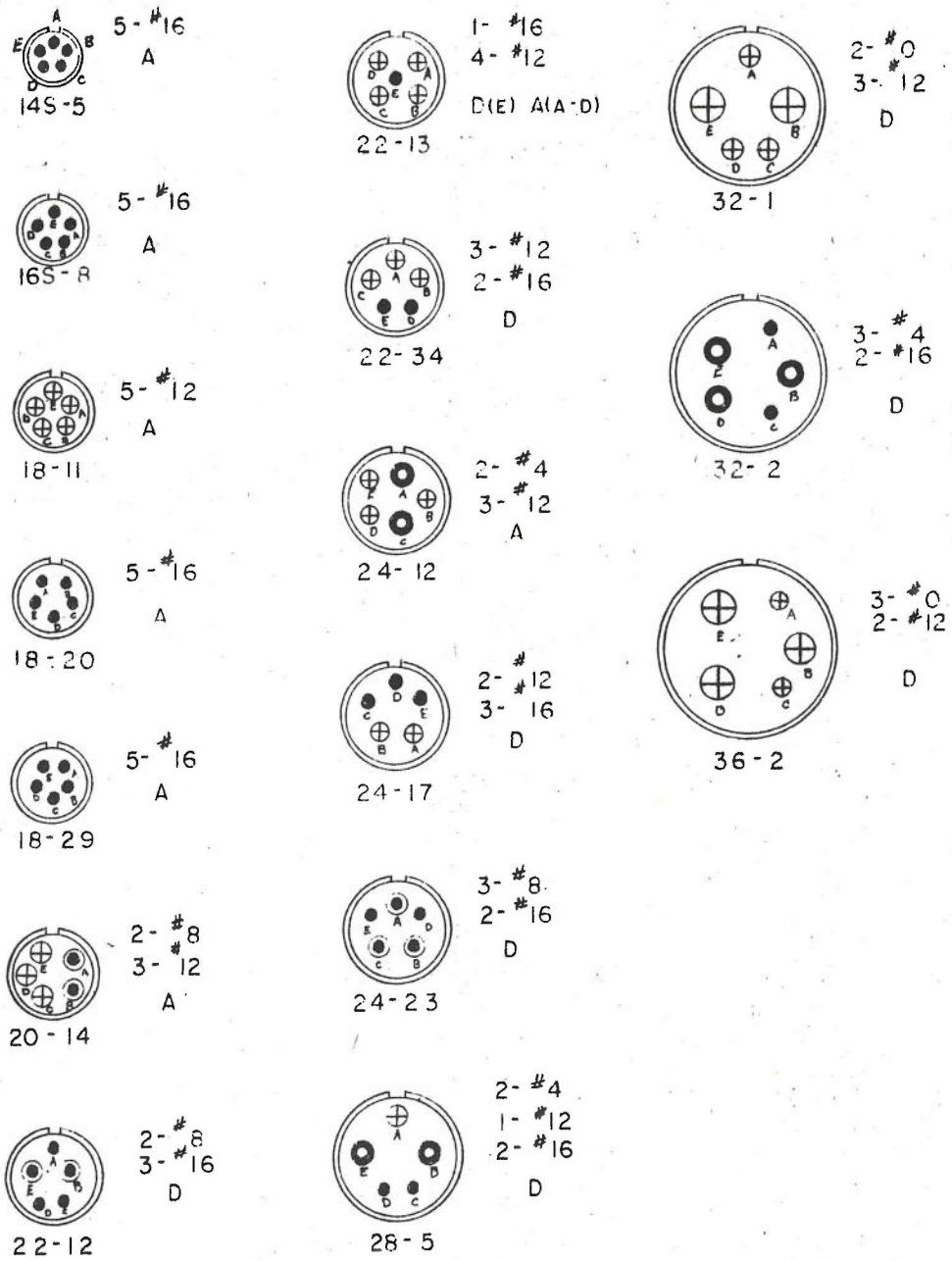

Figure 5-27. "AN" Insert Contact Arrangements - 5 Contact

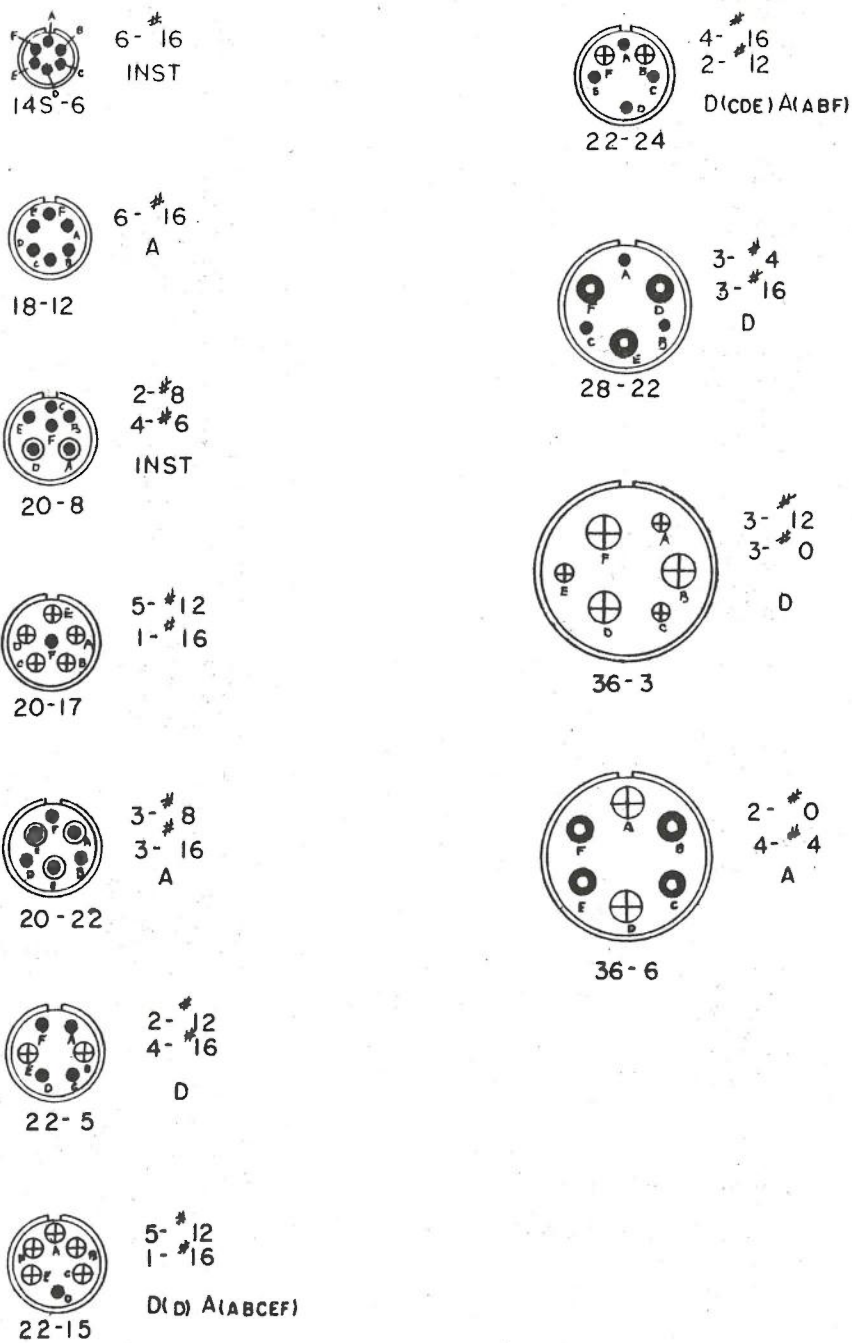

Figure 5-28. "AN" Insert Contact Arrangements - 6 Contact

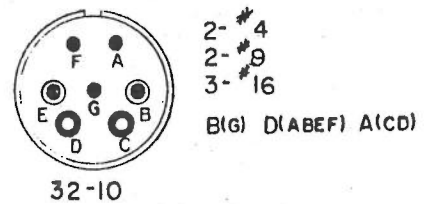
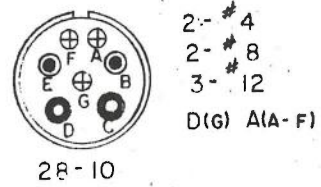
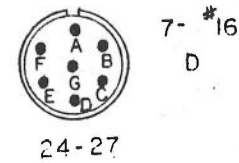
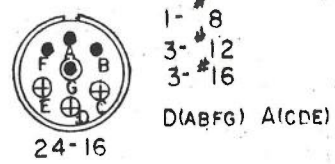
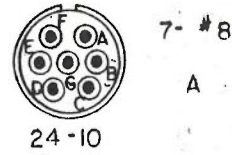
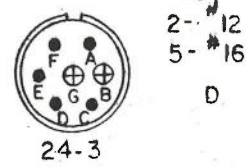
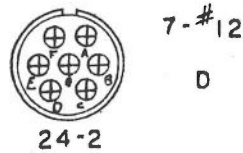
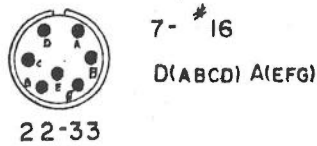
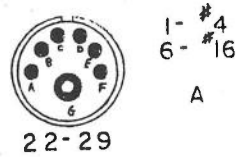
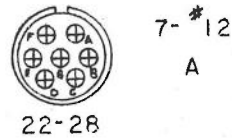
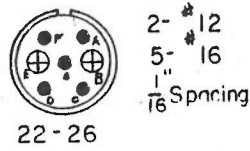
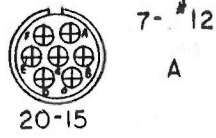
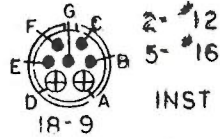
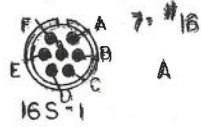

Figure 5-29. "AN" Insert Contact Arrangements- 7 Contact

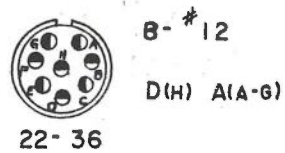
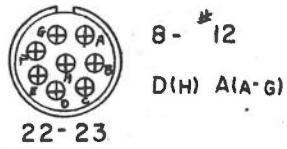
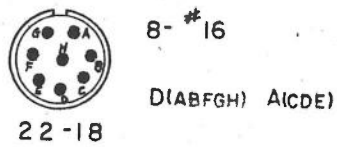
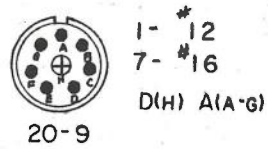
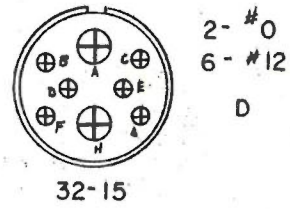
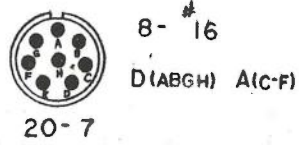
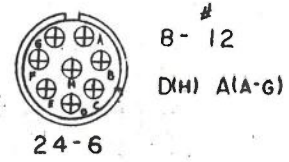
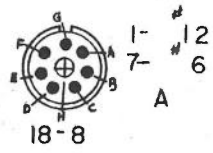

Figure 5-30. "AN" Insert Contact Arrangements - 8 Contact

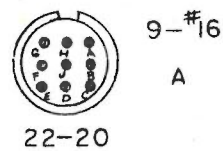
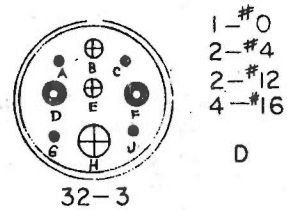
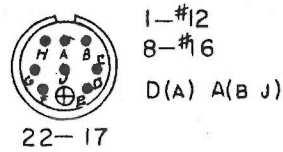
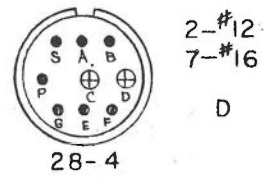
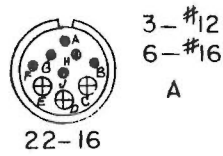
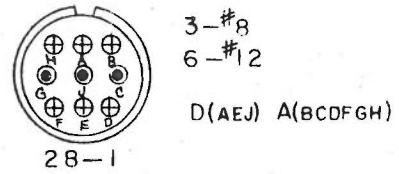
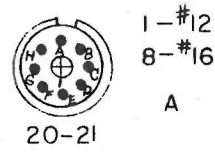
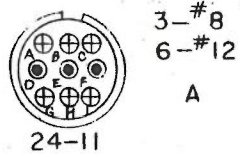
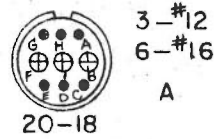
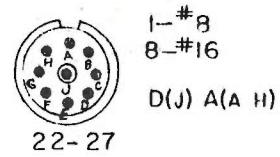
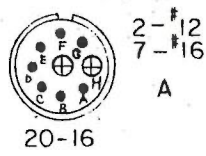
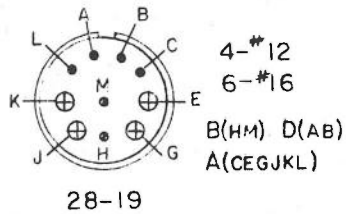
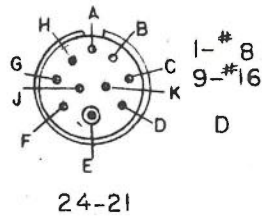
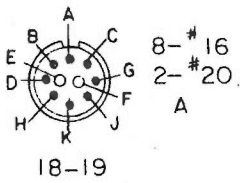
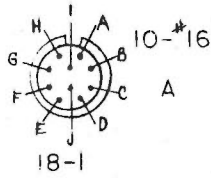

Figure 5-31. "AN" Insert Contact Arrangements - 9 Contact

10 CONTACT



11 CONTACT

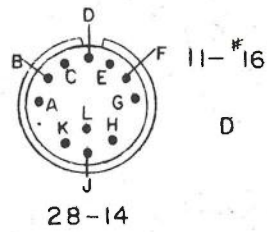
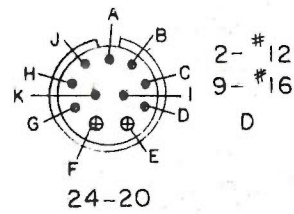
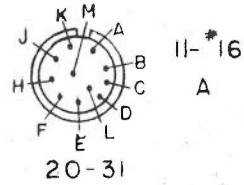

Figure 5-32, "AN" Insert Contact Arrangements- 10 & 11 Contact

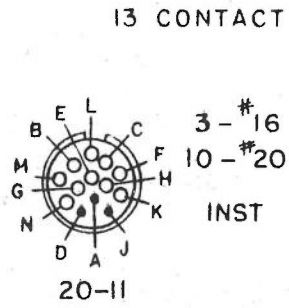
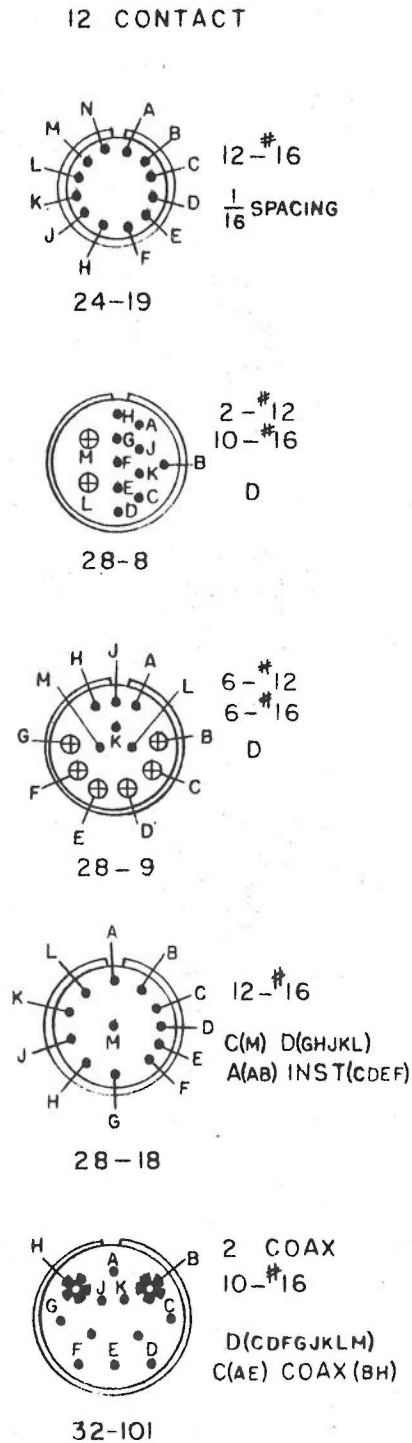

Figure 5-33. "AN" Insert Contact Arrangements - 12 & 13 Contact

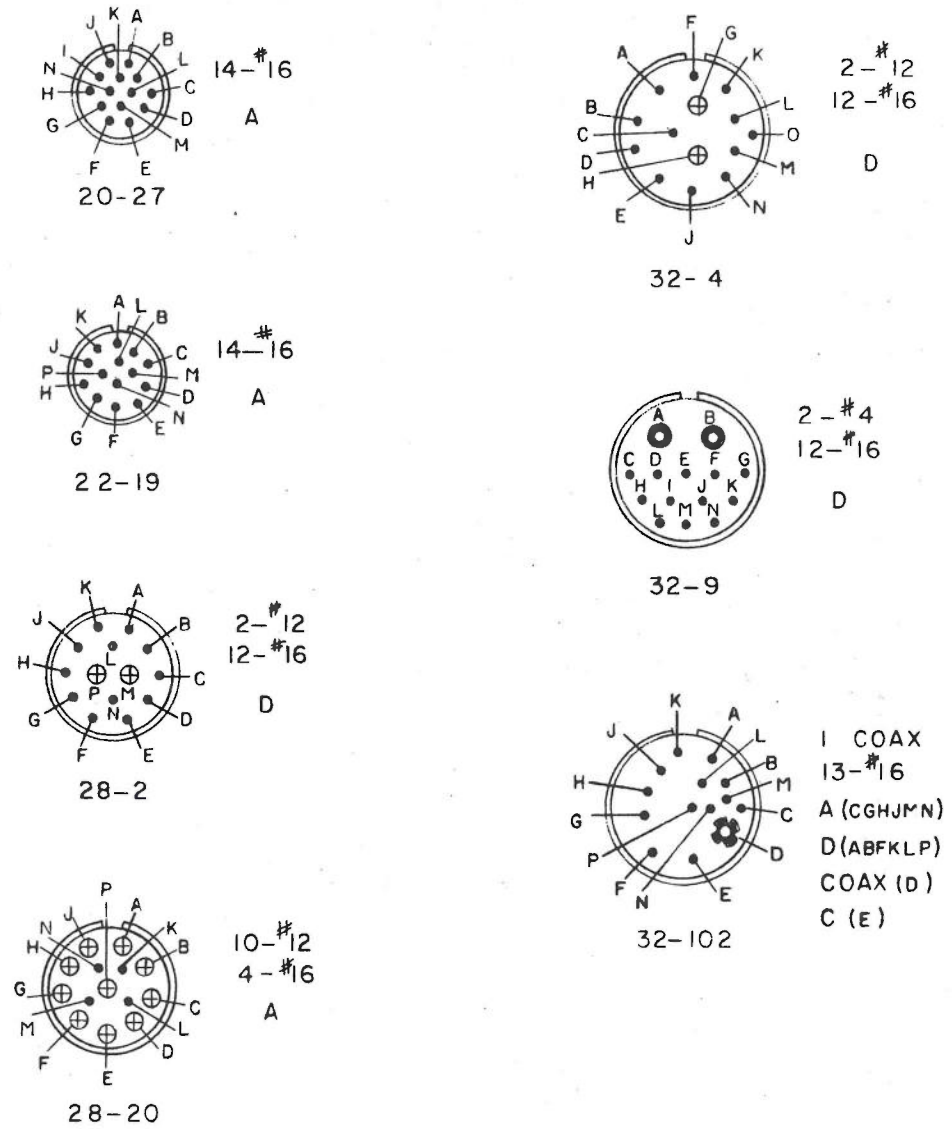
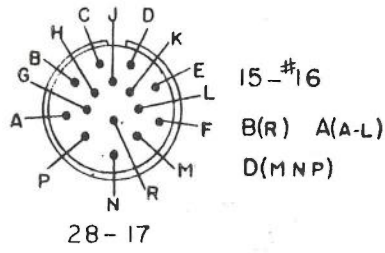

Figure 5-34. "AN" Insert Contact Arrangements - 14 Contact

15 CONTACT



16 CONTACT

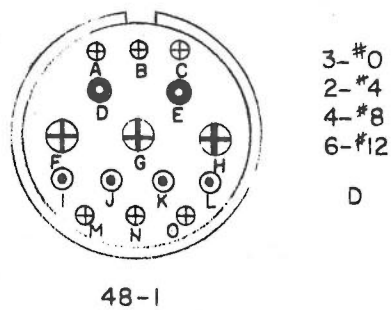
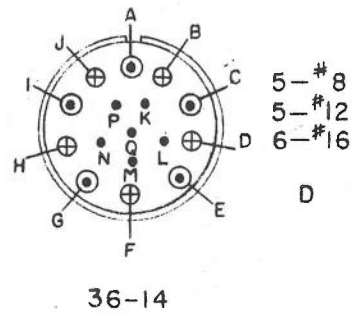
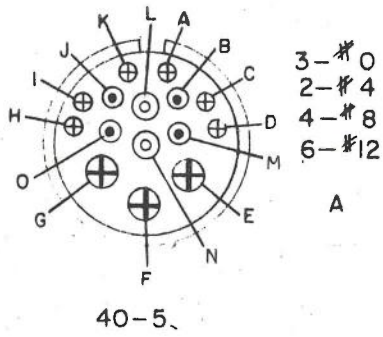
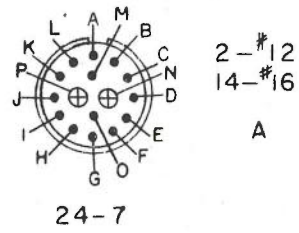
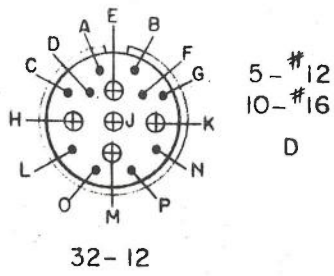
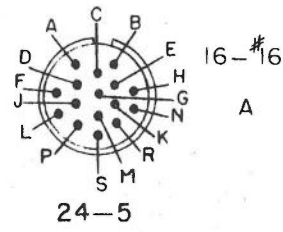
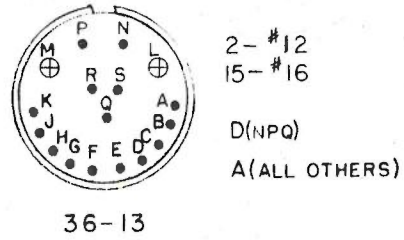
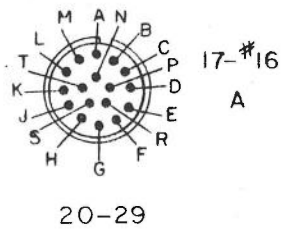
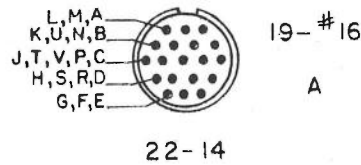

Figure 5-35. "AN" Insert Contact Arrangements- 15 & 16 Contact

17 CONTACT



19 CONTACT
(READ FROM LEFT TO RIGHT)



20 CONTACT
(READ FROM LEFT TO RIGHT)

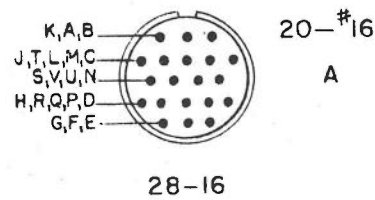

Figure 5-36. "AN" Insert Contact Arrangements - 17, 19 & 20 Contact

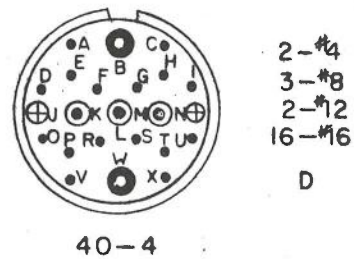
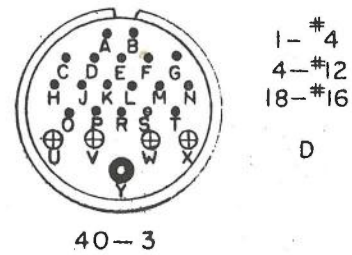
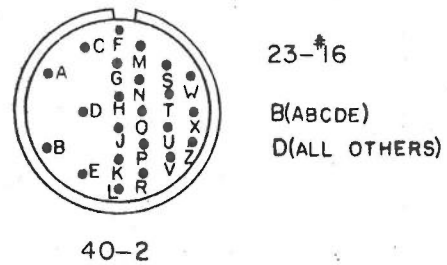
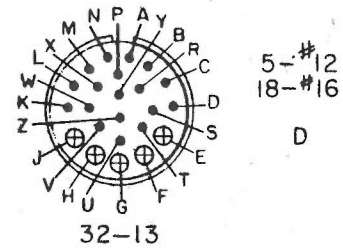
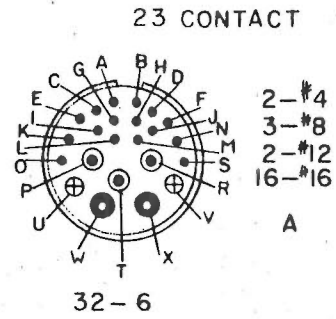
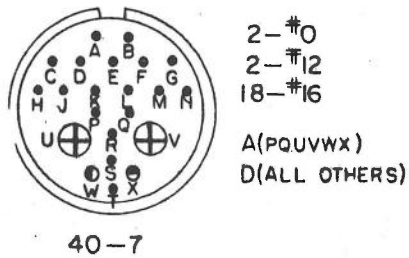
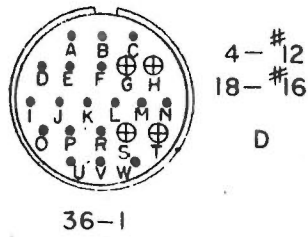
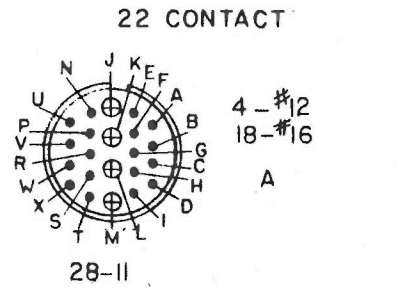
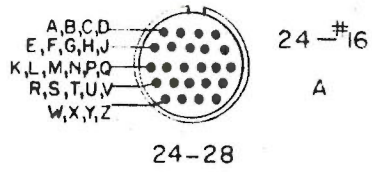
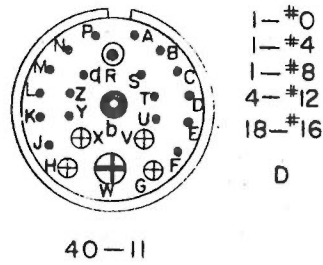

Figure 5-37. "AN" Insert Contact Arrangements - 22 & 23 Contact

24 CONTACT
(READ FROM LEFT TO RIGHT)



25 CONTACT



26 CONTACT



Figure 5-38. "AN" Insert Contact Arrangements-24, 25 & 26 Contact

29 CONTACT

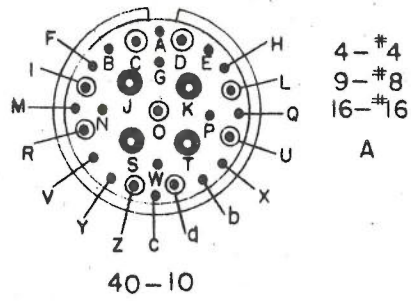

30 CONTACT

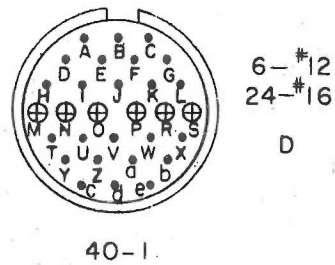
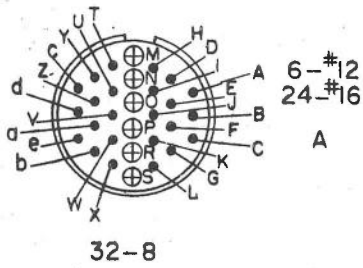
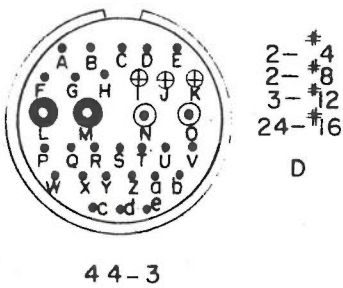
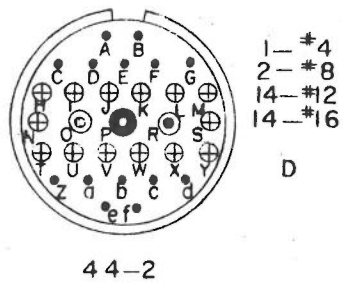
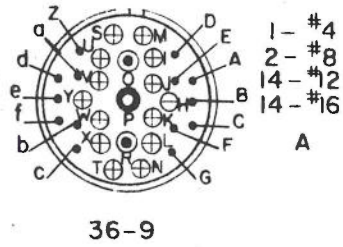

Figure 5-39. "AN" Insert Contact Arrangements - 29 & 30 Contact

31 CONTACT



35 CONTACT
(READ FROM LEFT TO RIGHT)

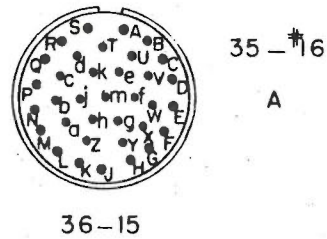
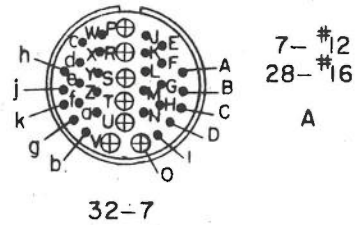
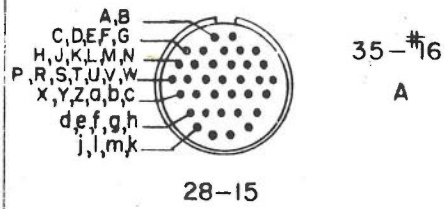
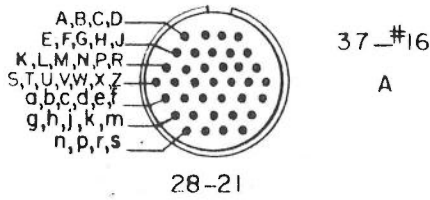
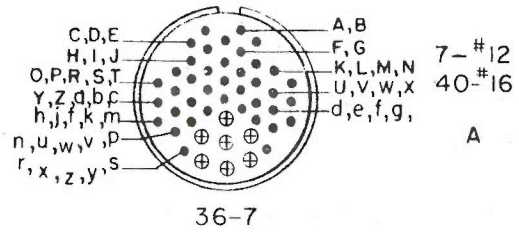

Figure 5-40. "AN" Insert Contact Arrangements - 31 & 35 Contact

37 CONTACT
(READ FROM LEFT TO RIGHT)



47 CONTACT
(READ FROM LEFT TO RIGHT)



41 CONTACT

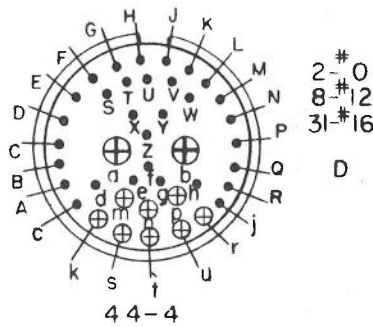

(READ DOWN)

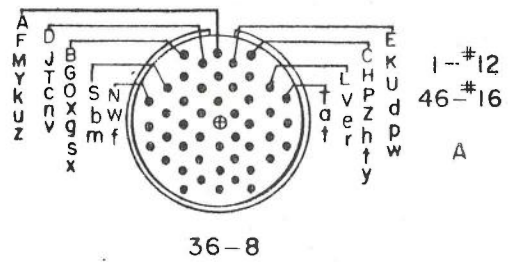

(READ DOWN)

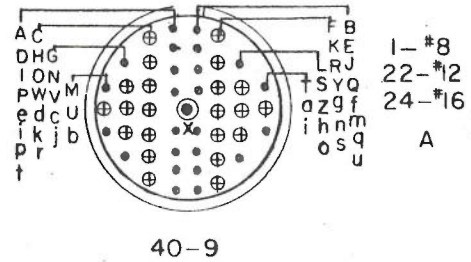

42 CONTACT

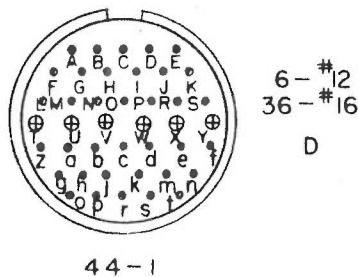

48 CONTACT
(READ FROM LEFT TO RIGHT)

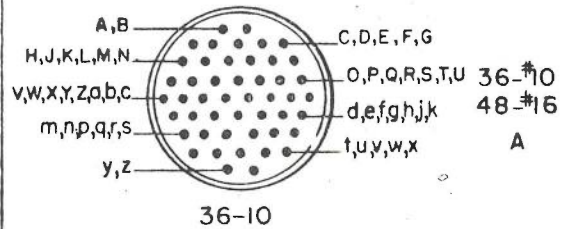

Figure 5-41. "AN" Insert Contact Arrangements-37, 41 & 42 Contact

Figure 5-42, "AN" Insert Contact Arrangements-47 & 48 Contact

(5) CONTACT TYPE.- Use the following rule in deciding whether a pin or socket contact is to be used. Use socket contacts on the live side of the connector assembly. In this manner, the hot lead will not be exposed if the cable is disconnected since the socket type gives more protection when exposed than does the pin type. The socket type contact is designated as "S", the pin type as "P".

b. CHOOSING THE SHELL STYLE. - The choice of shell style depends upon the application. Decide whether a plug or receptacle is to be used. Refer back to paragraph 7 on shell design to aid in choosing between solid shell, split shell, etc. If a plug, decide on whether a straight or right angle plug is to be used.

c. CONNECTOR PART NUMBER. - The complete part number consists of the shell number, insert number and contact type letter. Example:AN 3100A-16-11P, the shell style number is 3100A, a solid shell receptacle.

The insert number is 16-11, having two number 12 contacts and service rating A. The first number (16) indicates the shell size.

The letter "P" indicates pin type contacts.

d. INSERT SELECTION EXAMPLE.- A 30-volt circuit has one AWG No.8, one AWG No.16 conductor, and one AWG No. 18 conductor.

The total number of contacts is three. Refer to the insert specifications for three contacts (Figure 5-25). Note that insert 16-7 has one No.8 contact and two No.16 contacts. Since there is no size 18 contact, use the next largest size, in this case No. 16. This insert arrangement has service rating A which is entirely adequate since the peak voltage is less than 200 volts. Therefore this is the correct insert for the job.

A convenient reference is available in the "Insert Specifications", Tables 5-3 through 5-7.

These tables give total number of contacts, service rating and the number of contacts of each size for all insert numbers.

For example the following can be determined about connector AN 3100-16-11P:

Look up insert number 16-11 (Table 5-3). This connector has two number 12 contacts, and service rating A.

TABLE 5-3. INSERT SPECIFICATIONS (8S-1 TO 18-19)

Insert Number	Total Contacts	Service Rating	Contact Size						
			No. 0	No. 4	No. 8	No. 12	No. 16	No. 20	
8S-1	1	A					1		
10S-2	1	A					1		
10SL-3	3	A					3		
10SL-4	2	A					2		
12S-3	2	A					2		
12S-4	1	D					1		
12-5	1	D				1			
12S-6	2		THERMOCOUPLE						2
14S-1	3	A					3		
14S-2	4	A					4		
14-3	1	D			1				
14S-4	1	D					1		

TABLE 5-3. INSERT SPECIFICATIONS (Cont'd) (8S-1 TO 18-19)

Insert Number	Total Contacts	Service Rating	Contact Size					
			No. 0	No. 4	No. 8	No. 12	No. 16	No. 20
14S-5	5	A					5	
14S-6	6	INST.					6	
14S-7	3	A					3	
14S-9	2	A					2	
16S-1	7	A					7	
16-2	1	D				1		
16S-3	1	B					1	
16S-4	2	D					2	
16S-5	3	A					3	
16S-6	3	A					3	
16-7	3	A			1		2	
16S-8	5	A					5	
16-9	4	A				2	2	
16-10	3	A				3		
16-11	2	A				2		
16-12	1	A		1				
16-13	2	A		THERMO.		2		
18-1	10	A					10	
18-3	2	D				2		
18-4	4	D					4	
18-5	3	D				2	1	
18-6	1	D		1				
18-7	1	B			1			
18-8	8	A				1	7	
18-9	7	INST.				2	5	
18-10	4	A				4		
18-11	5	A				5		
18-12	6	A					6	
18-13	4	A			1	3		
18-14	2	A		1			1	
18-15	4	A		THERMO.		4		
18-16	1	C				1		
18-19	10	A					8	2

TABLE 5-4. INSERT SPECIFICATIONS (18-20 TO 22-15)

Insert Number	Total Contacts	Service Rating	Contact Size					
			No. 0	No. 4	No. 8	No. 12	No. 16	No. 20
18-20	5	A					5	
18-22	3	D					3	
18-29	5	A					5	
20-2	1	D	1					
20-3	3	D				3		
20-4	4	D				4		
20-5	2	D					2	

TABLE 5-4. INSERT SPECIFICATIONS (Cont'd) (18-20 TO 22-15)

Insert Number	Total Contacts	Service Rating	Contact Size					
			No. 0	No. 4	No. 8	No. 12	No. 16	No. 20
20-6	3	D					3	
20-7	8	D					4	
		A				4		
20-8	6	INST.			2		4	
20-9	8	D				1		
		A				7		
20-11	13	INST.					3	10
20-12	2	A		1			1	
20-13	4	A	SHORT CIRCUIT				4	
20-14	5	A			2	3		
20-15	7	A				7		
20-16	9	A				2	7	
20-17	6	A				5	1	
20-18	9	A				3	6	
20-19	3	A			3			
20-20	4	A		1		3		
20-21	9	A				1	8	
20-22	6	A			3		3	
20-23	2	A			2			
20-24	4	A			2		2	
20-26	3	A	SHORT CIRCUIT			3		
20-27	14	A					14	
20-29	17	A					17	
22-1	2	D			2			
22-2	3	D			3			
22-3	2	D		1			1	
22-4	4	A			2	2		
22-5	6	D				2	4	
22-6	3	D			2		1	
22-7	1	D	1					
22-8	2	D				2		
22-9	3	D				3		
22-10	4	D					4	
22-11	2	B					2	
22-12	5	D			2		3	
22-13	5	D					1	
		A				4		
22-14	19	A					19	
22-15	6	D					1	
		A				5		

TABLE 5-5. INSERT SPECIFICATIONS (22-16 TO 24-28)

Insert Number	Total Contacts	Service Rating	Contact Size						
			No. 0	No. 4	No. 8	No. 12	No. 16	No. 20	
22-16	9	A				3	6		
22-17	9	D					1		
		A				1	7		
22-18	8	D					5		
		A					3		
22-19	14	A					14		
22-20	9	A					9		
22-21	3	A	1					2	
22-22	4	A			4				
22-23	8	D				1			
		A				7			
22-24	6	D					3		
		A				2	1		
22-25	3	A	1				2		
22-26	7					2	5		
22-27	9	D			1				
		A					8		
22-28	7	A				7			
22-29	7	A					6		
22-33	7	D					4		
		A					3		
22-34	5	D				3	2		
22-36	8	D	THERMOCOUPLE			1			
		A				7			
24-1	2	D	1			1			
24-2	7	D				7			
24-3	7	D				2	5		
24-4	4	D	1				3		
24-5	16	A					16		
24-6	8	D				1			
		A				7			
24-7	16	A				2	14		
24-9	2	A		2					
24-10	7	A			7				
24-11	9	A			3	6			
24-12	5	A		2		3			
24-14	3	A	1			2			
24-16	7	D			1		3		
		A				3	3		
24-17	5	D				2	3		
24-18	4		SHORT CIRCUIT					4	
24-19	12						12		
24-20	11	D				2	9		
24-21	10	D			1		9		
24-22	4	D			4				
24-23	5	D			3		2		
24-27	7	D					7		
24-28	24	A					24		

TABLE 5-6. INSERT SPECIFICATIONS (28-1 TO 32-12)

Insert Number	Total Contacts	Service Rating	Contact Size					
			No. 0	No. 4	No. 8	No. 12	No. 16	No. 20
28-1	9	D			1	2		
		A			2	4		
28-2	14	D				2	12	
28-3	3	D			3			
28-4	9	D				2	7	
28-5	5	D		2		1	2	
28-6	3	D		3				
28-7	2	D		2				
28-8	12	D				2	10	
28-9	12	D				6	6	
28-10	7	D				1		
		A		2	2	2		
28-11	22	A				4	18	
28-12	26	A					26	
28-14	11	D					11	
28-15	35	A					35	
28-16	20	A					20	
28-17	15	B					1	
		D					3	
		A					11	
28-18	12	C					1	
		D					5	
		A					2	
		INST.					4	
28-19	10	B					2	
		D					2	
		A				4	2	
28-20	14	A				10	4	
28-21	37	A					37	
28-22	6	D		3			3	
32-1	5	D	2			3		
32-2	5	D		3			2	
32-3	9	D	1	2		2	4	
32-4	14	D				2	12	
32-5	2	D	2					
32-6	23	A		2	3	2	16	
32-7	35	A				7	28	
32-8	30	A				6	24	
32-9	14	D		2			12	
32-10	7	B					1	
		D			2		2	
		A		2				
32-12	15	D				5	10	

TABLE 5-7. INSERT SPECIFICATIONS (32-13 TO 48-1)

Insert Number	Total Contacts	Service Rating	Contact Size					
			No. 0	No. 4	No. 8	No. 12	No. 16	No. 20
32-13	23	D				5	18	
32-15	8	D	2			6		
32-17	4	D		4				
32-101	12		TWO COAX CONTACTS					
		C					2	
		D					8	
32-102	14		ONE COAX CONTACT					
		C					1	
		D					6	
		A					6	
36-1	22	D			4	18		
36-2	5	D	3			2		
36-3	6	D	3			3		
36-4	3	D	1					
		A	2					
36-5	4	A	4					
36-6	6	A	2	4				
36-7	47	A				7	40	
36-8	47	A				1	46	
36-9	31	A		1	2	14	14	
36-10	48	A					48	
36-13	17	D					3	
		A				2	12	
36-14	16	D			5	5	6	
36-15	35	A					35	
40-1	30	D				6	24	
40-2	23	B					5	
		D					18	
40-3	23	D		1		4	18	
40-4	23	D		2	3	2	16	
40-5	15	A	3	2	4	6		
40-6	26	D	1			1	24	
		D					16	
40-7	22	A	2			2	2	
		A				1	22	24
40-9	47	A			1	22	24	
40-10	29	A		4	9		16	
40-11	25	D	1	1	1	4	18	
44-1	42	D				6	36	
44-2	31	D		1	2	14	14	
44-3	31	D		2	2	3	24	
44-4	41	D	2			8	31	
48-1	15	D	3	2	4	6		

10. SPECIAL CONNECTOR NOTES.

a. ALTERNATE POSITION INSERTS.—AN specs provide for "Alternate Arrangements" which means that the connector insert is rotated, with respect to the shell, a specified number of degrees from the normal position. This is done to prevent mismatching when several connectors of the same size and arrangement are installed close to one another. These alternate arrangements are identified with letter designations using the letters W, X, Y and Z and the

letters are added as a suffix to the normal AN identification. Example: AN 3100A-36-7PW means alternate position W.

Previous AN specifications used figures as identification for alternate positions. The new AN specifications do not recognize the use of these figured alternate positions and they should be used for replacement purposes only. Unless alternate positions are specified, connectors are supplied with inserts in standard position (Figure 5-43).

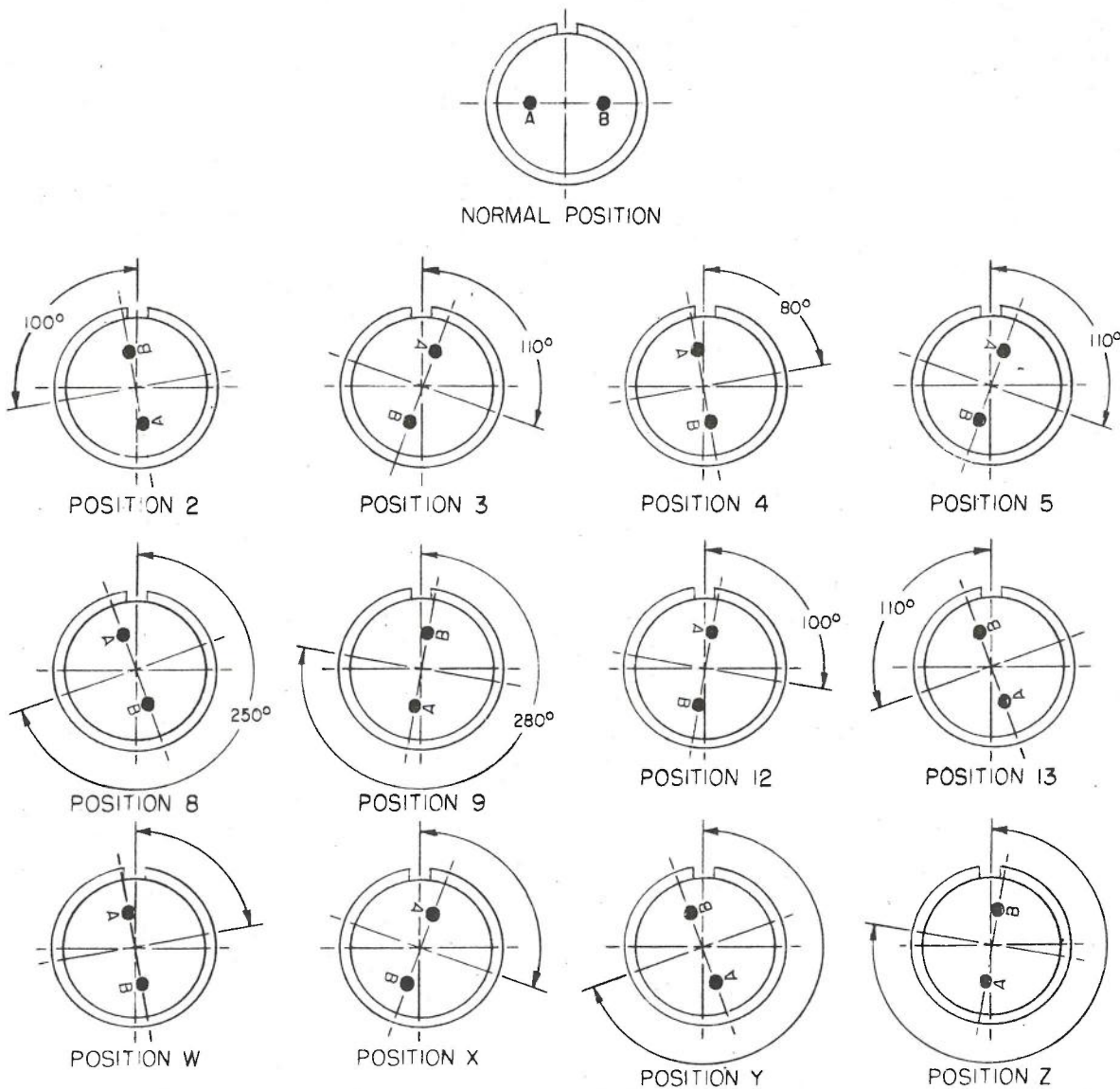

Figure 5-43. Alternate Position Inserts

b. **THERMOCOUPLE CONNECTORS.** - Thermocouple connectors are available in practically all "AN" shell styles. They are used in thermocouple circuits to give a detachable connection without introducing dissimilar metals. Contacts are normally made of iron and constantin. Chromal-alumel and copper-constantin are sometimes used.

c. **AUTOMATIC GROUNDING AND SHORT-CIRCUITING CONNECTORS.** - The contacts in these connectors automatically ground or short circuit as shown in Figure 5-44. Special cam-operated grounding springs are placed in female inserts which are similar in all other respects to the standard "AN" socket or female insert.

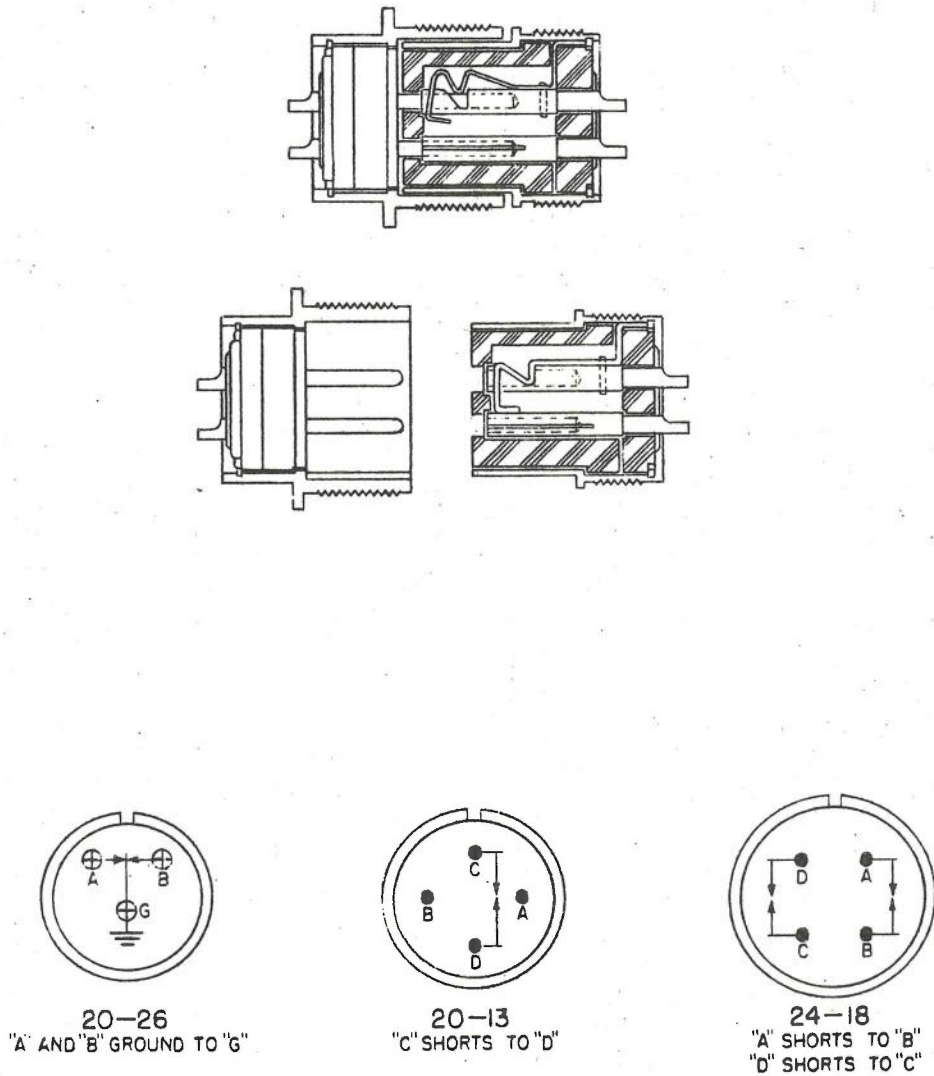

Figure 5-44. Automatic Grounding and Short-Circuiting Connectors

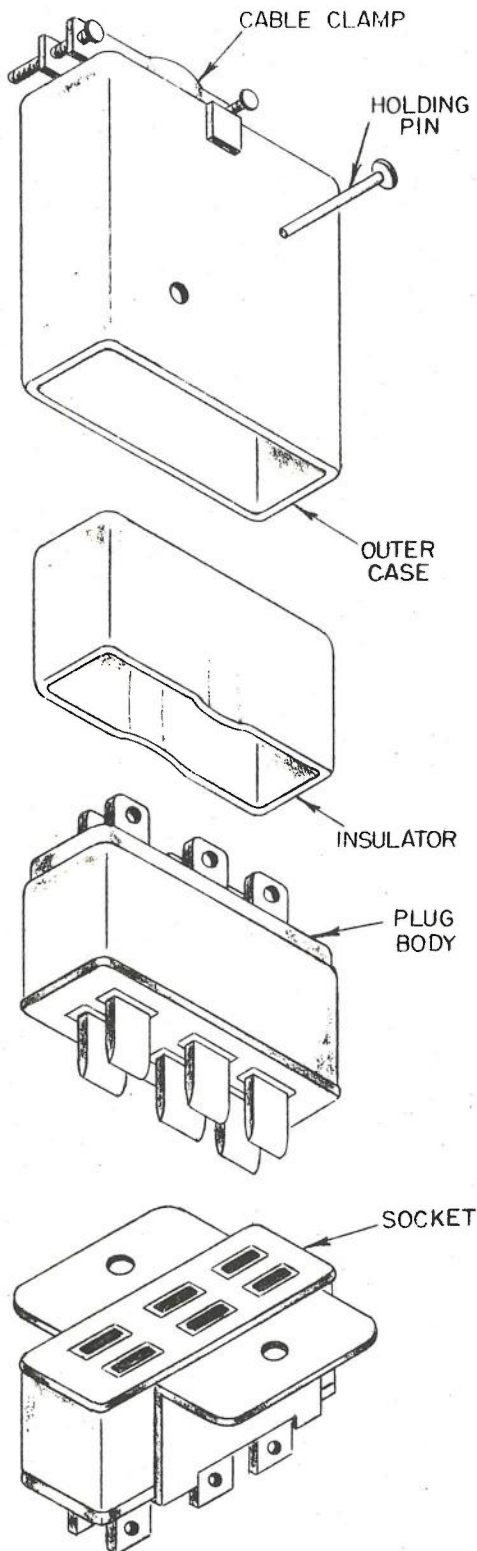

Figure 5-45. Jones Plug and Socket Assembly

d. JONES PLUGS AND SOCKETS. - Although Jones plugs and sockets and equivalent types are not "AN" type connectors, they are widely used for multi-circuit connections. Assembly is shown in Figure 5-45. They are used in applications of from 24 to 5000 volts and current ratings up to 25 amperes are available. The plug assembly is held in place by a single drive pin. Polarization is done with either a key or contact arrangement. Soldering to these types is similar to the procedure described for notched or perforated terminals.

Contacts are numbered on the soldering side of both plugs and sockets.

11. INSTALLATION.

a. SOLDERING TO THE CONNECTORS. - Make an accurate measure of all the conductors which go into the assembly.

Even if only one conductor of a group is too long, it will buckle within the connector and may cause trouble upon flexing. If the conductor is too short, the connection cannot be made. Place insulating sleeves, if used, over the conductors. Next strip the ends of the conductors with wire strippers. The length to strip depends upon the depth of the solder cups, which varies with the size of the contact. Use the following as a guide.

Contact	0	4	8	12	16	20
Strip	$\frac{3}{4}$ "	$\frac{5}{8}$ "	$\frac{5}{8}$ "	$\frac{5}{16}$ "	$\frac{1}{4}$ "	$\frac{1}{4}$ "
Conductor						
Insulation						

Gather a group of stripped conductors together and dip them into liquid flux which may be made up from powdered rosin (1 lb can; SNSN G52-R-650) and alcohol. To obtain a good mixture, fill a 1 pint jar to 1/4 depth with powdered rosin and then fill to the top with alcohol. Stir lightly until all the rosin is in solution. Shake off the excess flux and pre-tin the conductors by dipping them into a solder pot (SNSN G41-P-2600). (Figure 5-46.) Pre-tinning should be confined to the lower limits of the stripped conductors so as to allow flexibility.

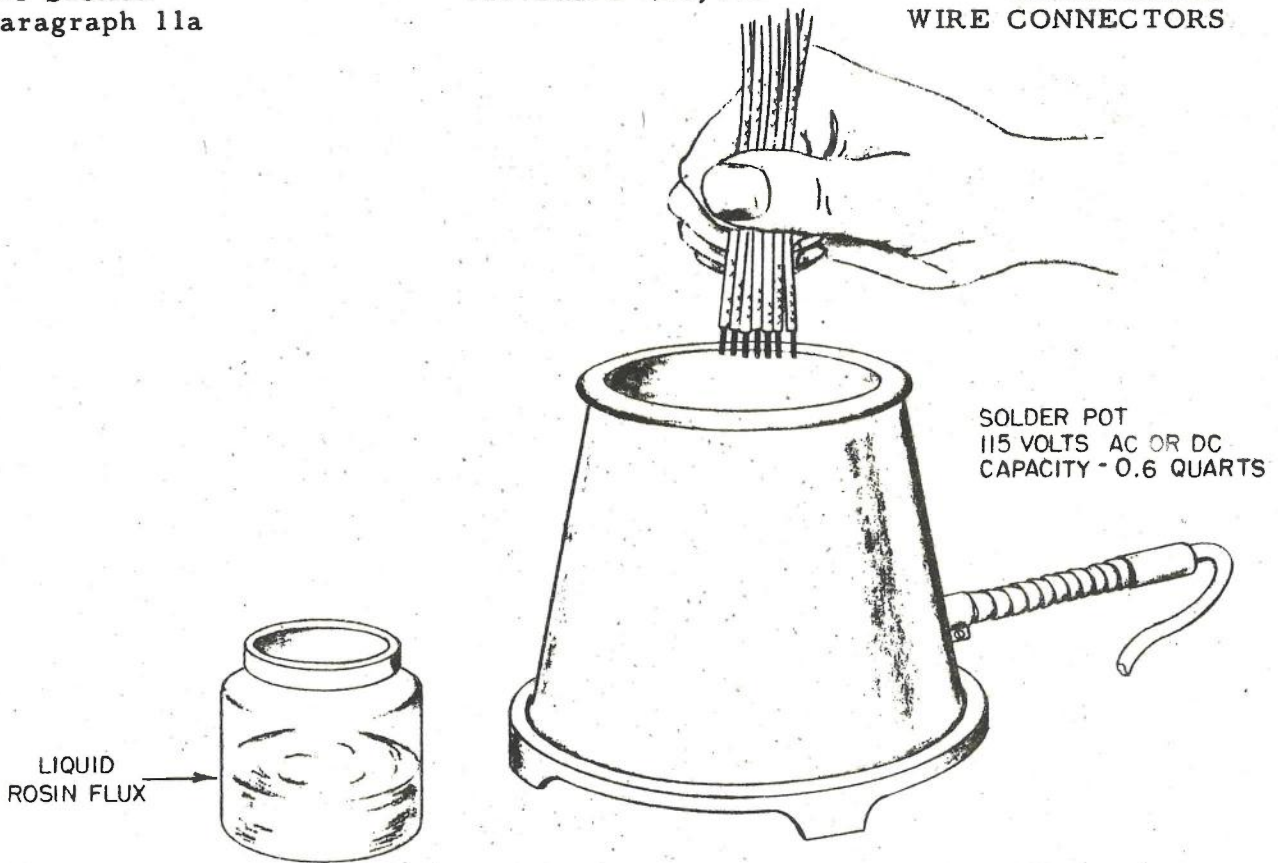

Figure 5-46. Pre-Tinning Conductors

If a system of coding is used by color, clip, tag, letter or numeral, attach the identifying marker to the conductor.

Check to see that all assembly parts which must be slipped over the conductors before soldering, such as cable clamps and coupling nuts, are in position.

Now start soldering the conductors to the solder cups. The following shows the correct iron for various contact sizes found in "AN" connectors:

- 100 watt iron --- wire gauge 22,20,18,
16, 12
- 200 watt iron --- wire gauge 10,8,6,4
- 300-500 watt iron-wire gauge 0

Begin with the bottom contact on the left and work across the bottom to the right (Figure 5-47). Flow solder into cup first. The iron should be applied to the open end of the solder cup to prevent solder from collecting on the outside of the contact. A chisel-shaped

iron point has given good results for this application. Insert the wire into the solder cup while holding the iron tip against the side of the cup. As the other side melts, push the wire into the cup. Keep the conductor steady while the solder cools.

CAUTION

The inserts are phenolic and may be damaged by heat, therefore, do not keep an iron too close to the insert for too long a period.

Remove the excess rosin and follow the above procedure for the remaining contacts.

After all the connections have been made, slip the insulating sleeving over the contacts to protect against shorting and corrosion. Tie the conductor bundle just behind the sleeving to prevent bend-

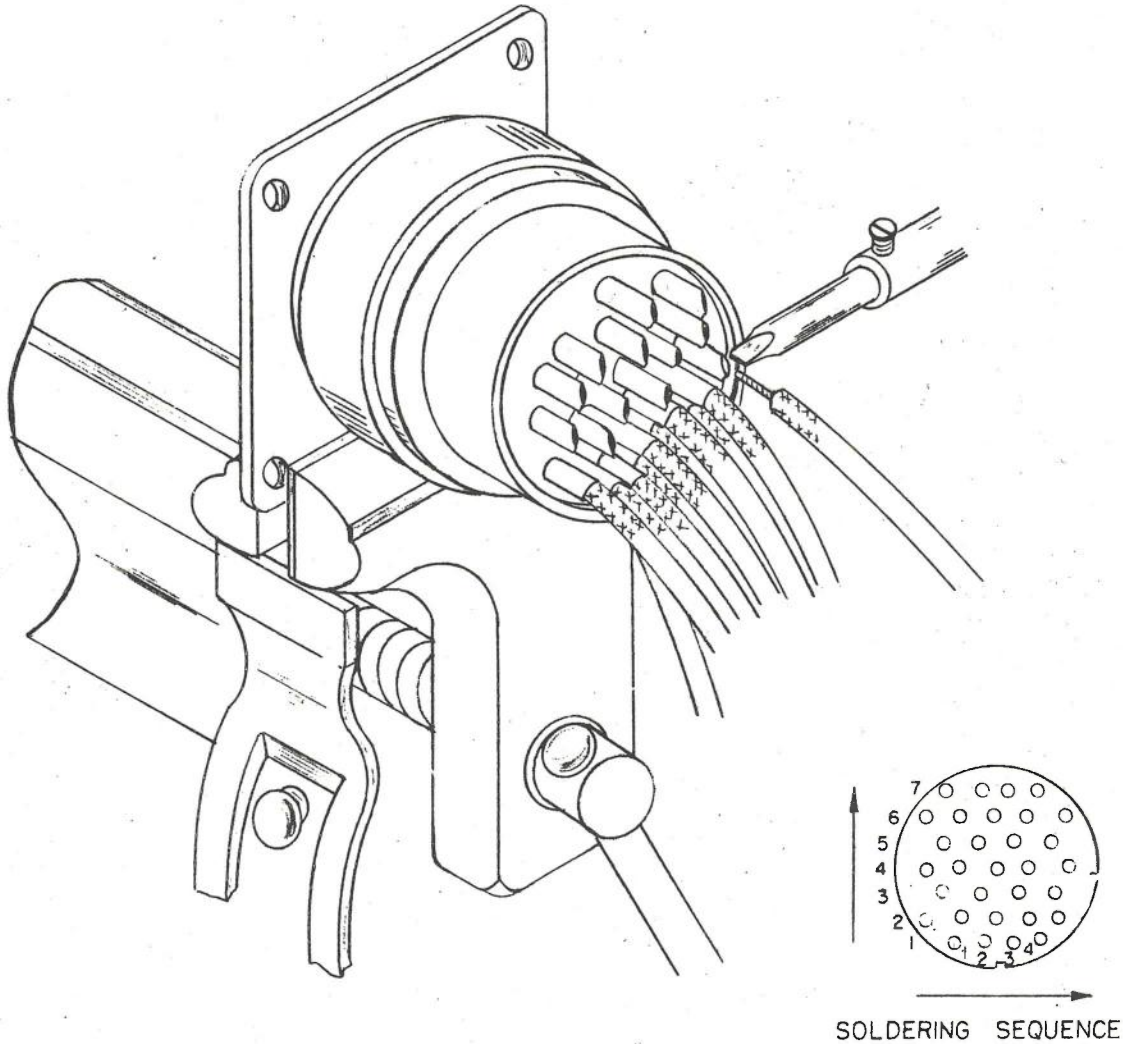

Figure 5-47. Soldering Cables to Contacts

ing or spreading (Figure 5-48) then re-assemble the remaining parts of the connector, if any.

Contacts of size 12 and smaller may be soldered in the connector, but those of size 8 and larger must be removed from the connector before soldering. Greater heat is needed to solder to these, and they are removed to protect the insert during the soldering operation.

First, pry up the retainer or locking ring with a 1/8 inch screwdriver. The parts can now be disassembled easily. Remove the contacts and support them in a jig or vise - not too tightly. Slip on

inserts or other parts which cannot be placed in position after soldering. Use a 300-watt iron for the number 2 and 4 contacts and a 500-watt iron for the number 0 contact. The tip should be shaped as shown in Figure 5-49. After the soldering operation is completed, reassemble the connector and snap the locking ring into place. Set the locking ring with its opening a little to one side of the groove in the connector shell (Figure 5-50). Place one end of the ring in the slot and follow around with pressure. Since it is a spring ring, it will snap into its groove.

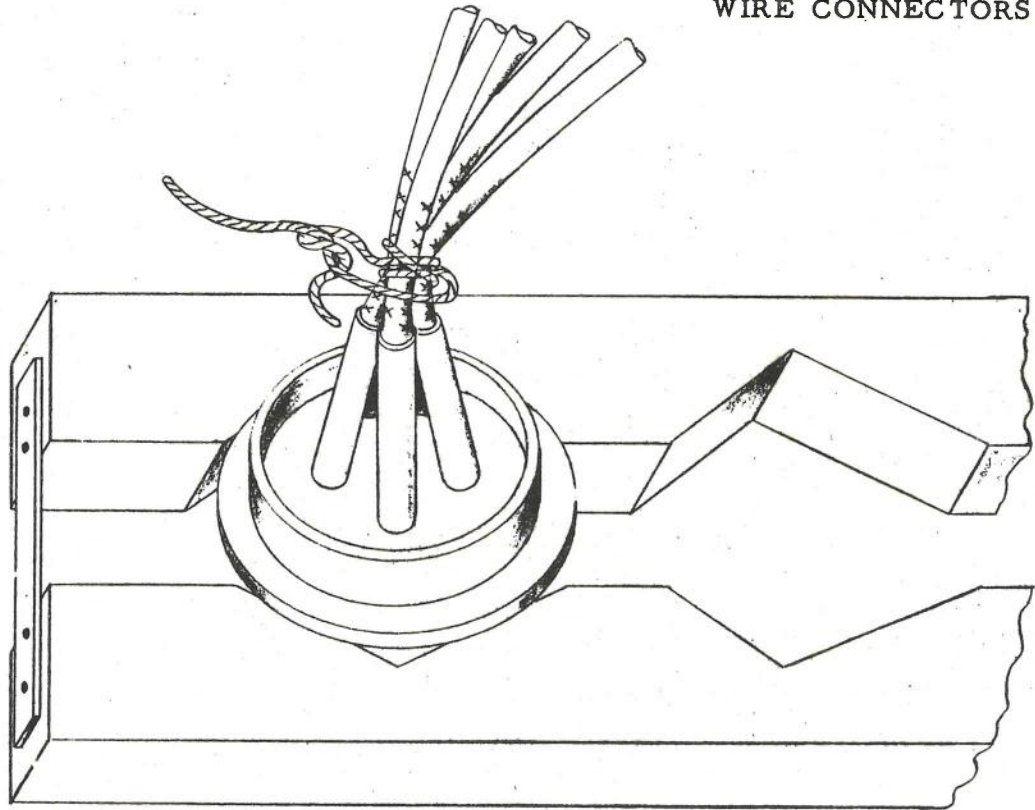

Figure 5-48. Tying Conductors with String

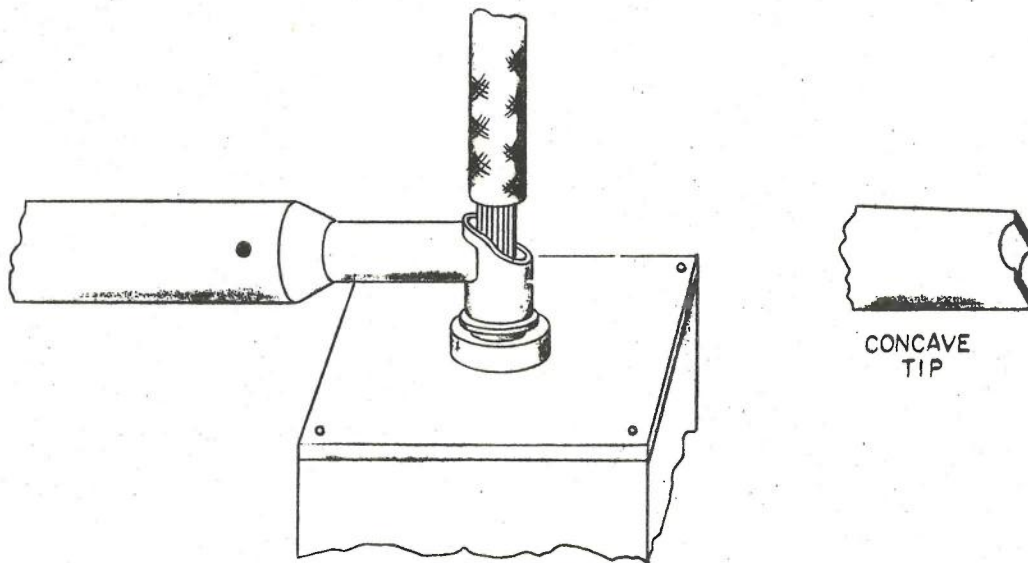

Figure 5-49. Soldering to Large Removable Contacts

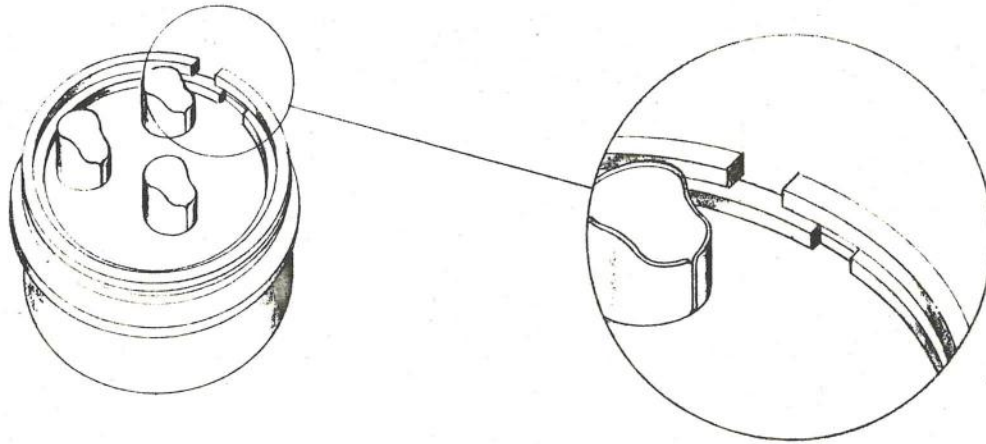

Figure 5-50. Position of Locking Rings

b. STRAIN RELIEF BAR. All Amphenol split-shell connectors are cast to receive a strain relief bar. It is used when conduit joins a connector and it absorbs all the flexing and twisting of wires which would take place at the

solder joint. When lacing the bar, pass one half of the total number of wires on each side of the bar, cross lace and knot the cord. In the lower figure (Figure 5-51) the bar is shown in position.

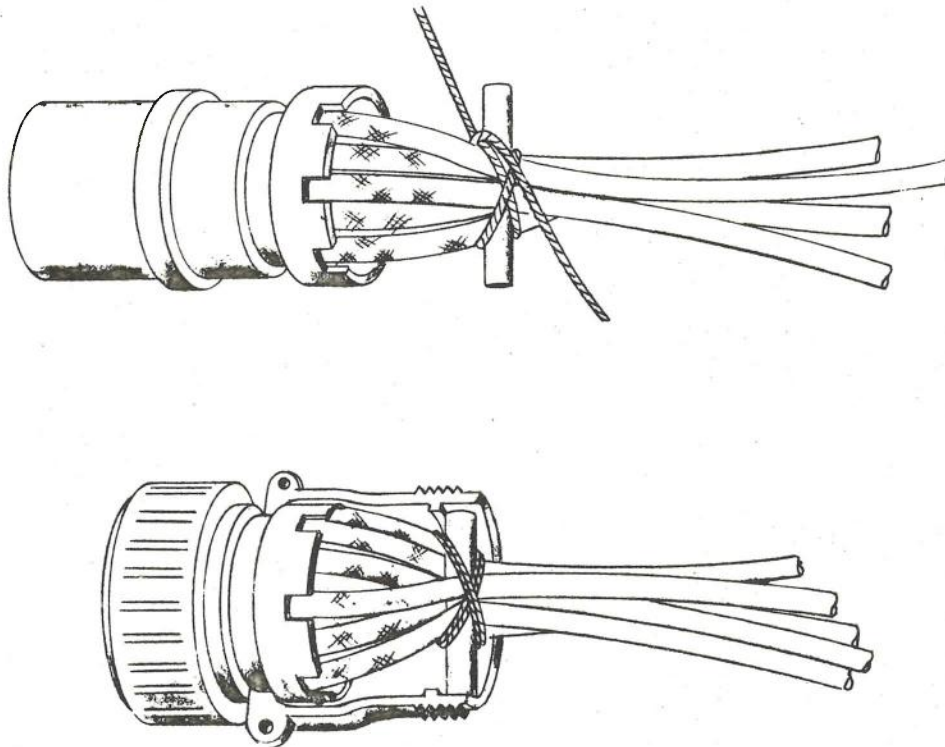

Figure 5-51. Strain Relief Bar

c. METHOD OF TERMINATING ARMORED CABLE AND SHIELDS AT "AN" CONNECTORS. - If an armored cable is terminated at an equipment by an "AN" type connector, a cable clamp must be used to provide continuity between the armor and the connector shell and to provide a good RF ground. Cable clamp AN 3057 is used with AN 3106 and AN 3108 standard plug. It may be used with AN 3101 cable connecting receptacle and AN 3100 receptacles when required to hold cables in order to prevent twisting or pulling of soldered connections and to secure cable armor or shields. This clamp is available in various sizes to fit any cable size from an outer diameter of 5/16 to 2-5/8 inch maximum. These sizes are shown in Table 5-8. The assembly of cable clamp AN 3057 is shown in Figure 5-52.

The approved method of clamping the cable armor is as follows (see Figure 5-52):

In preparing the cable, cut back enough of the armor and outer insulation jacket to allow the correct length of conductor from ferrule to soldering cups. Trim out all the filler. Strip the conductors and pre-tin. Slip on the cable clamp, brass washer, rubber gasket and ferrule in that order. When the Amphenol split-shell design is used, the ferrule may be slipped on and soldered to the shielding. Soldering is done on the side that will be within the connector housing. If the solid-shell type design is used, the grounding ring is soldered after the wires are soldered to the contacts and the back shell is in position. The ferrule may be either full or split to simplify installation. It is made from a washer identical to the washer supplied with the connector.

The clamp may then be threaded on the shell and tightened, providing a good connection between the cable armor and the connector shell.

TABLE 5-8. AN 3057 Cable Clamp Data

"AN" Number	Fits Shell Size	Max OD Cable	Threads
AN 3057-3	8S, 10S	5/16	1/2 - 28
AN 3057-4	12, 12S	3/8	5/8 - 24
AN 3057-6	14, 14S	1/2	3/4 - 20
AN 3057-8	16, 16S	5/8	7/8 - 20
AN 3057-10	18	3/4	1 - 20
AN 3057-12	20, 22	7/8	1 3/16 - 18
AN 3057-16	24, 28	1 1/8	1 7/8 - 18
AN 3057-20	32	1 7/16	1 3/4 - 18
AN 3057-24	36	1 9/16	2 - 18
AN 3057-28	40	1 13/16	2 1/4 - 16
AN 3057-32	44	2	2 1/2 - 16
AN 3057-40	48	2 5/8	3 - 16

EXAMPLE: CABLE TYPE DHFA-3
(FOR ALUMINUM ARMOR CABLE TYPES,
SEE ALTERNATE METHOD)

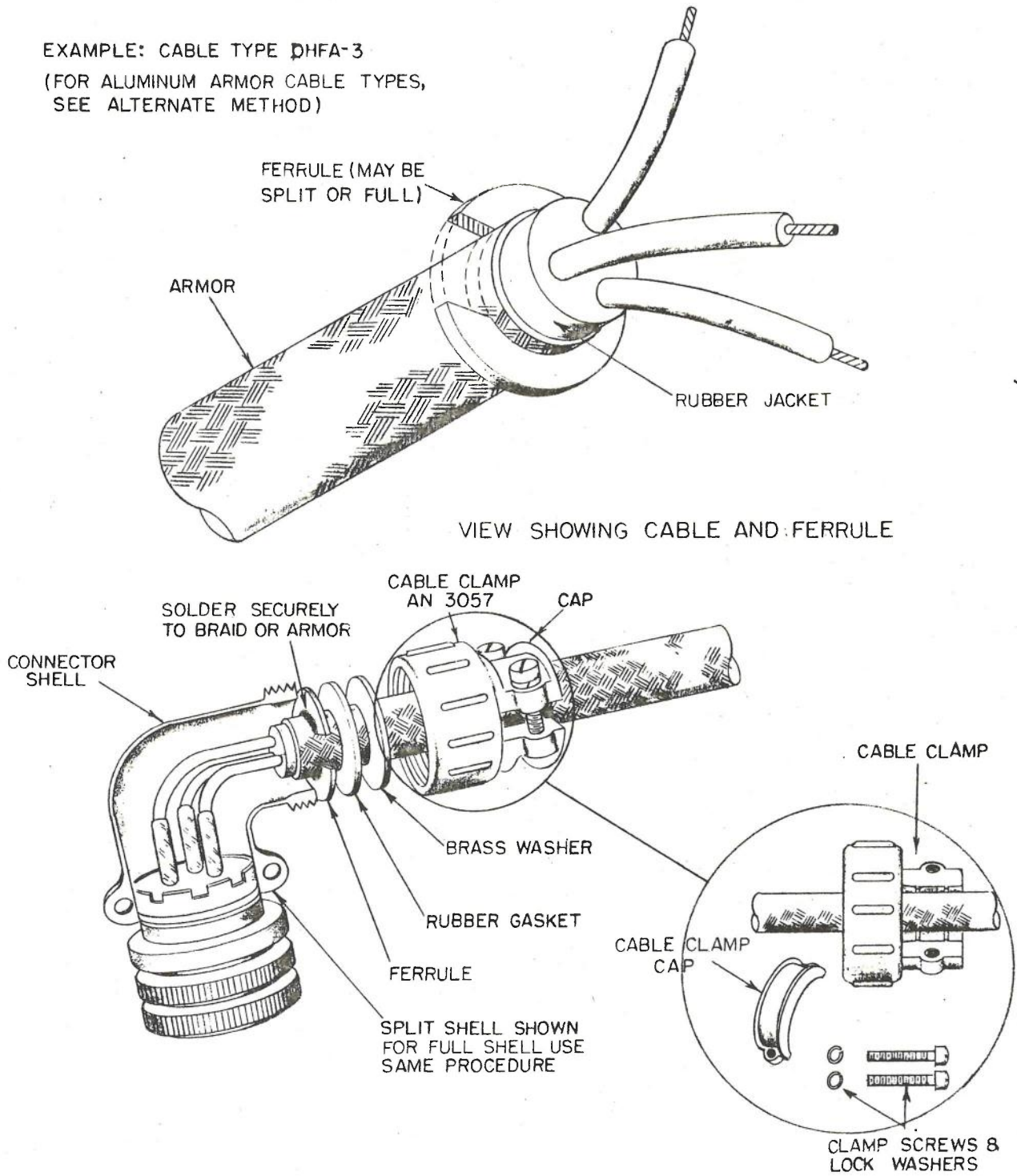

Figure 5-52. Terminating Cable Armor at "AN" Connectors

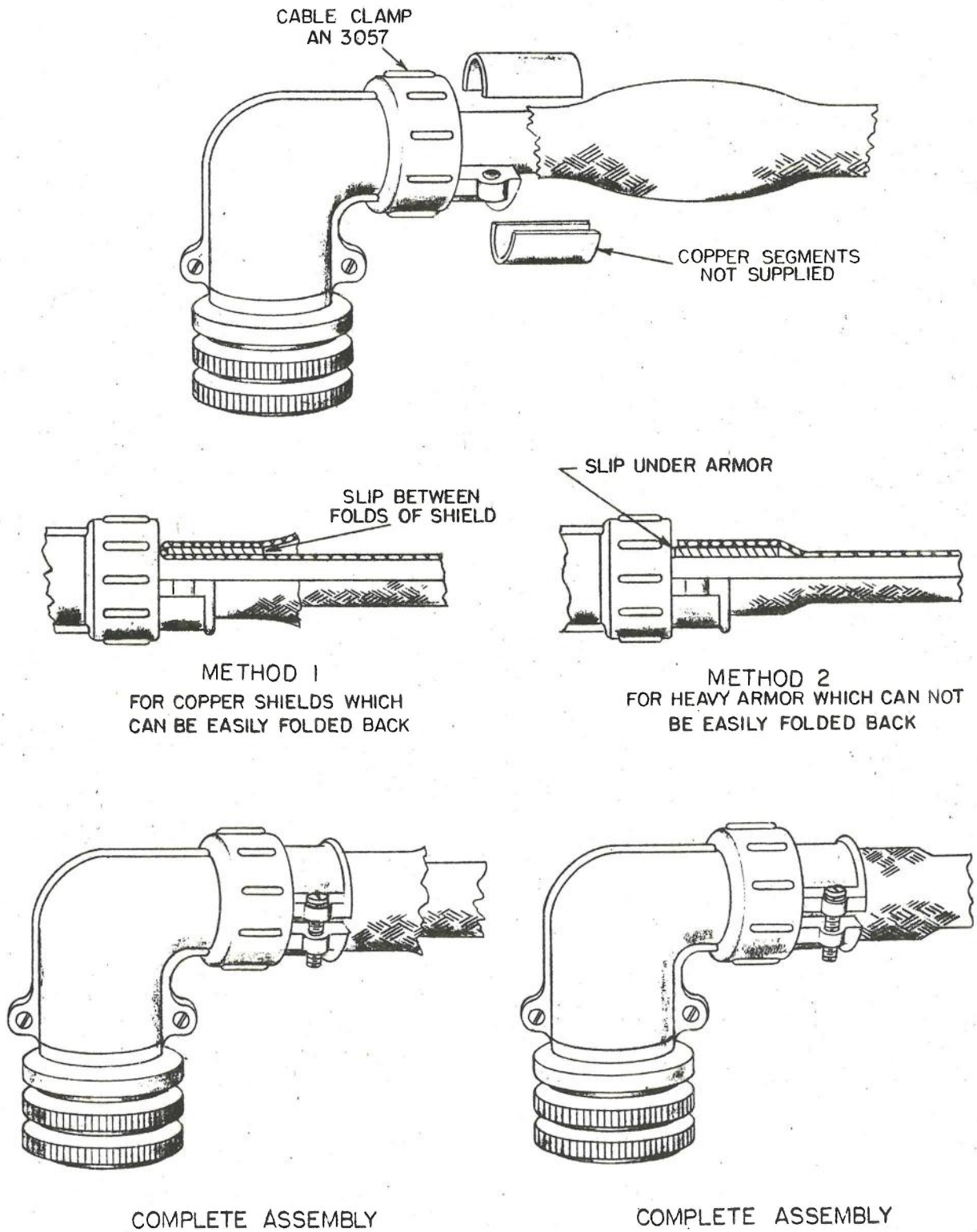

Figure 5-53. Alternate Method of Grounding Armor at "AN" Connectors

A second method which may be used, if the armor is aluminum such as on the reduced diameter types or any such type that cannot be soldered, is shown in Figure 5-53. The cable is prepared in the usual manner except that the armor is cut flush with the end of the conductors and is then pushed back out of the way. The cable clamp used should be of sufficient size to accommodate a maximum OD slightly larger than the cable. A piece of copper tubing approximately the diameter of the cable is then taken and cut about an inch long. It is split down the center so that the two halves may be placed around the cable armor. The armor is folded back and the two split halves are pushed into place in the cable clamp. The clamp is then tightened and the copper forms a protective shell around the cable so that a good secure ground will be maintained.

CAUTION

Aluminum or die cast connectors are usually anodized and this anodizing is an RF insulator. Make sure that all mating parts which form part of the ground return are thoroughly cleaned when the assembly is made.

d. CLAMP FOR UNARMORED CABLES. - Cable clamp AN 3057 may be used to obtain a firm grip on unarmored cables or conductor groupings of small diameter. The cable or grouping should be centered in the jaws of the clamp. A vinyl or rubber bushing or sleeve may be used for this purpose (Figure 5-54). For applications where the cable is subject to considerable flexing, the

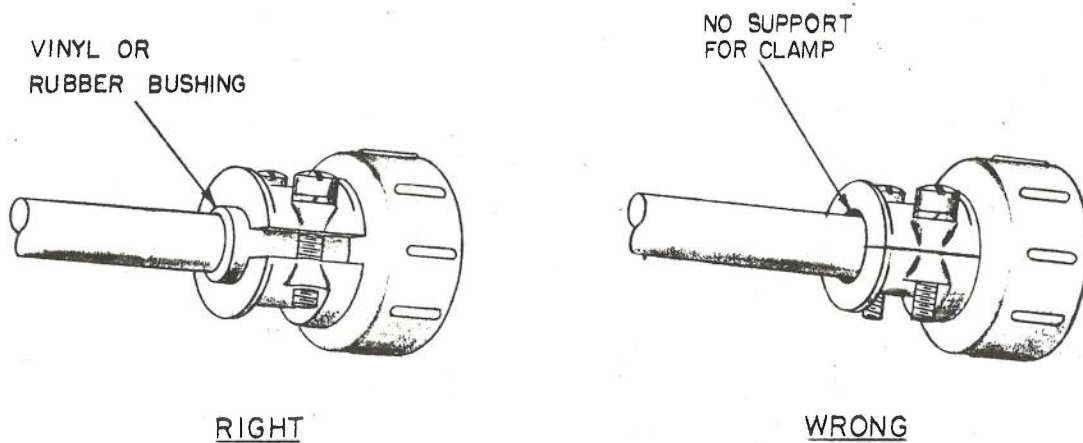

Figure 5-54. Use of Cable Clamp An 3057

resilient sleeve should project for several inches along the wire.

e. SAFETY WIRING. - Coupling rings on plug types AN 3106 and AN 3108 are provided with two or more drilled holes for safety wiring in order to prevent the ring from loosening or vibrating free of its mating thread. The holes are large enough to accommodate a 0.032 inch wire.

f. GENERAL INSTALLATION HINTS.

(1) When installing pressurized connectors, removal of the insert from the shell is not recommended, since this breaks the pressure seal incorporated at the time of factory assembly.

(2) Keep inserts, contacts and the inside surfaces of shells free of dirt, grease or oil at all times. Clean off foreign matter with clean acetone or trichlorethylene.

(3) When tightening or loosening threaded parts of a connector, support all plug assemblies by mating them with a proper receptacle. Fully engage and tighten the coupling nut.

Support the receptacle by carefully clamping the flange in a vise. Strap wrenches are recommended for tightening coupling nuts and back shells (Figure 5-55). If strap wrenches are not avail-

able, water pump pliers with leaded jaws may be used. Care must be taken not to break or deform the coupling nut.

(4) In some types of moisture proof or type "M" connectors, grommets having a tapering hole for the passage of conductors are used immediately in back of the solder cups. To avoid difficulty in pushing the conductors through the grommet holes, cut off the conductors at an angle of 45° and apply a small amount of Dow Corning No. 4 or petralatum to the ends of the conductor. Push the conductors through the grommet from the back toward the end having the small projections. This is shown in Figure 5-70. Rubber covered conductors should be used with grommets to get the most effective water-proofing properties.

(5) The inserts of pressurized terminals are usually of one piece construction with contacts molded in. The insert is sealed on the shell and no attempt should be made to remove them. The larger contacts (size 8 or larger) have provisions for removal to prevent damage to the insert by heat.

(6) Table 5-9 shows coupling thread size for various "AN" shell sizes.

(7) Exploded views of some of the more common types of connectors are shown in Figures 5-56 through 5-71.

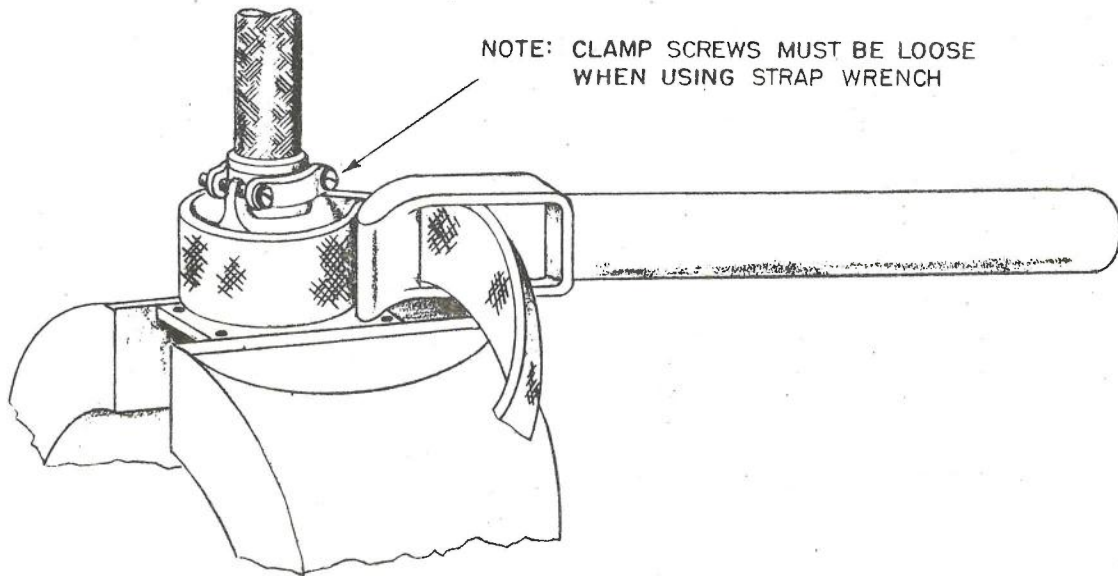

Figure 5-55. Strap Wrench

TABLE 5-9. COUPLING THREAD SIZE FOR VARIOUS "AN" SHELL SIZES

AN SHELL SIZE	COUPLING THREAD SIZE Class 2 Fit
8s	1/2 - 28
10s	5/8 - 24
12s	3/4 - 20
14s	7/8 - 20
16s	1 - 20
12	3/4 - 20
14	7/8 - 20
16	1 - 20
18	1 1/8 - 18
20	1 1/4 - 18
22	1 3/8 - 18
24	1 1/2 - 18
28	1 3/4 - 18
32	2 - 18
36	2 1/4 - 16
40	2 1/2 - 16
44	2 3/4 - 16
48	3 - 16

WITH SOCKET INSERT (FEMALE)

- A BACK SHELL
- B RETAINER RING
- F SOCKET REAR INSERT
- G SOCKET CONTACT
- H SOCKET FRONT INSERT
- J FRONT SHELL

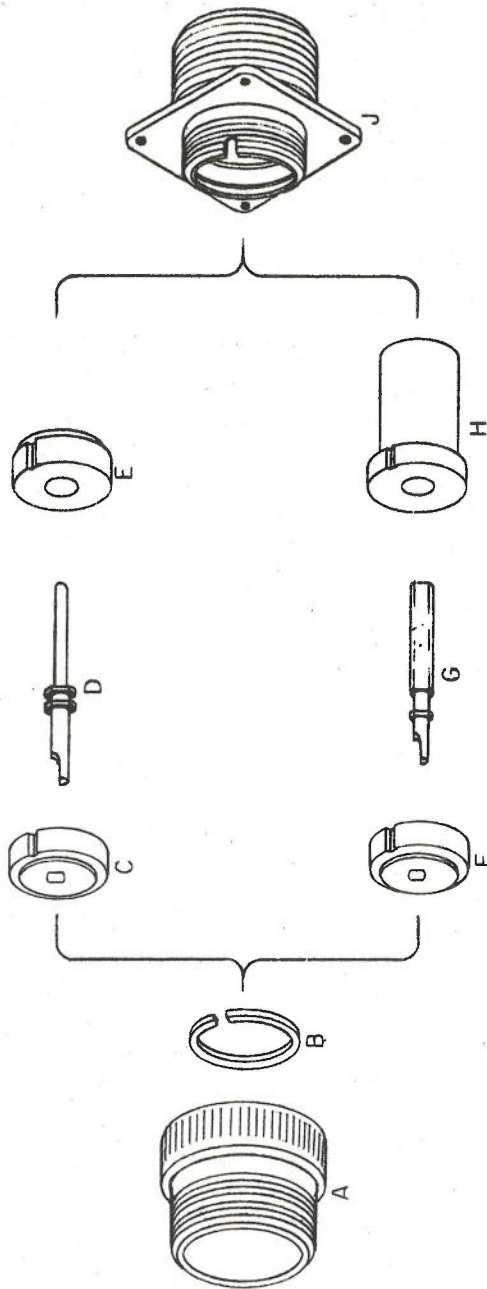
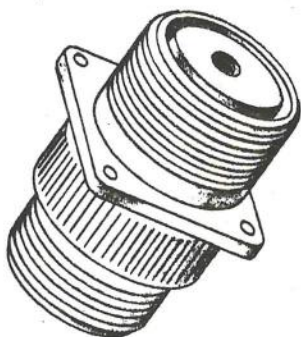

WITH PIN INSERT (MALE)

- A BACK SHELL
- B RETAINER RING
- C PIN REAR INSERT
- D PIN CONTACT
- E PIN FRONT INSERT
- J FRONT SHELL

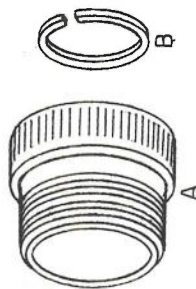

Figure 5-56. Amphenol AN 3100A Solid Shell Wall Receptacle

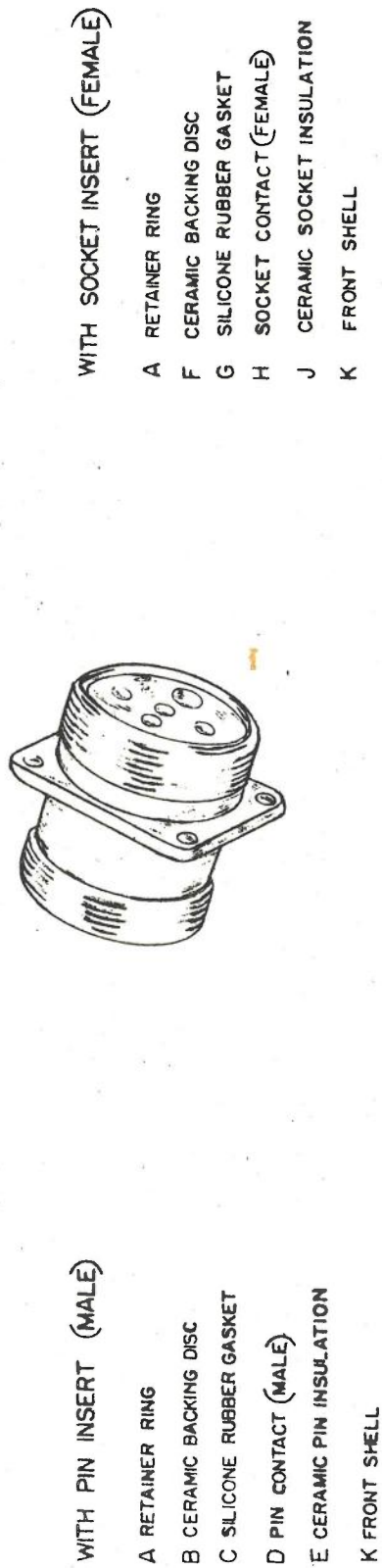

Figure 5-58, Amphenol AN 3100K Shielded Receptacle

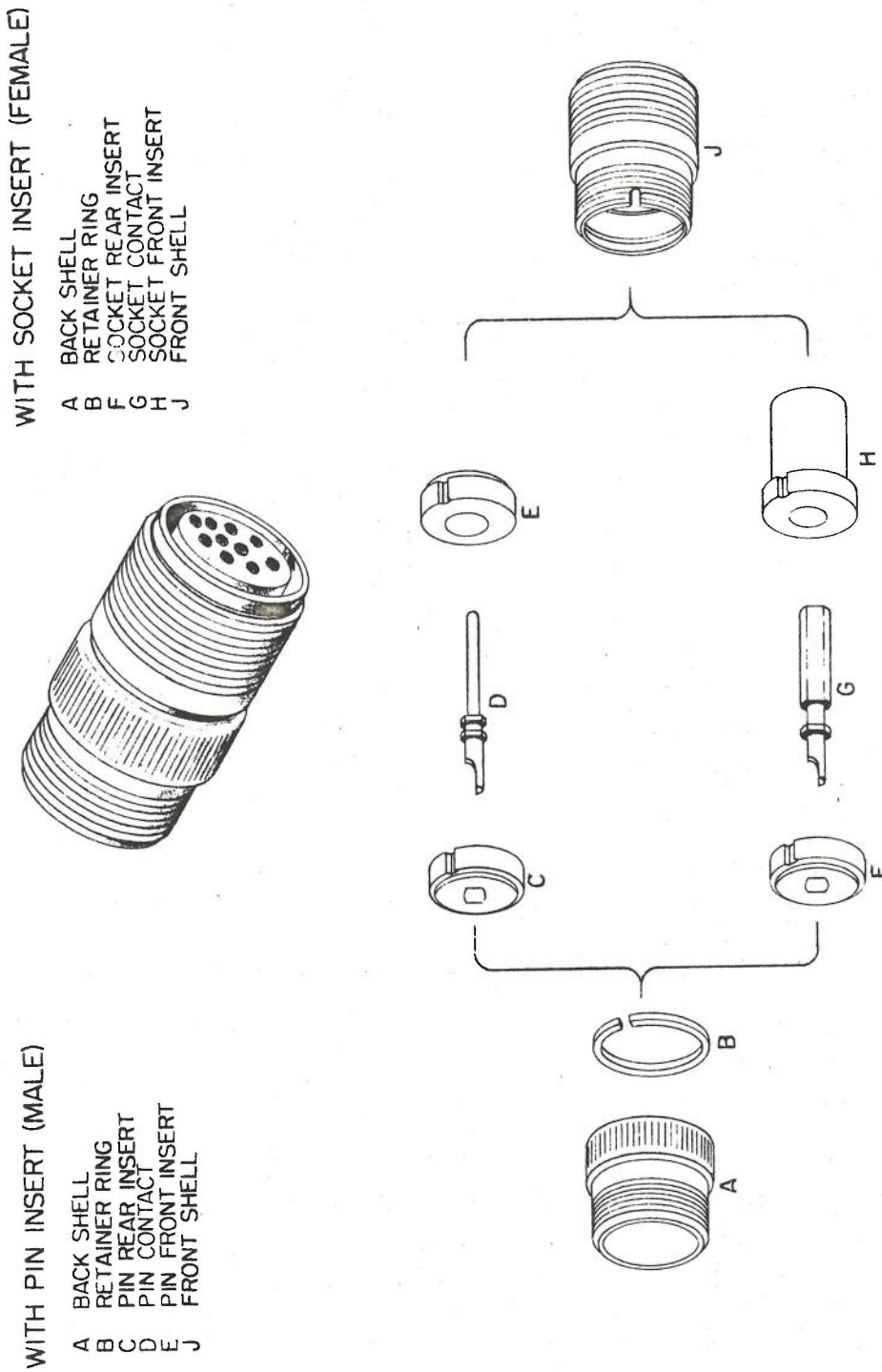
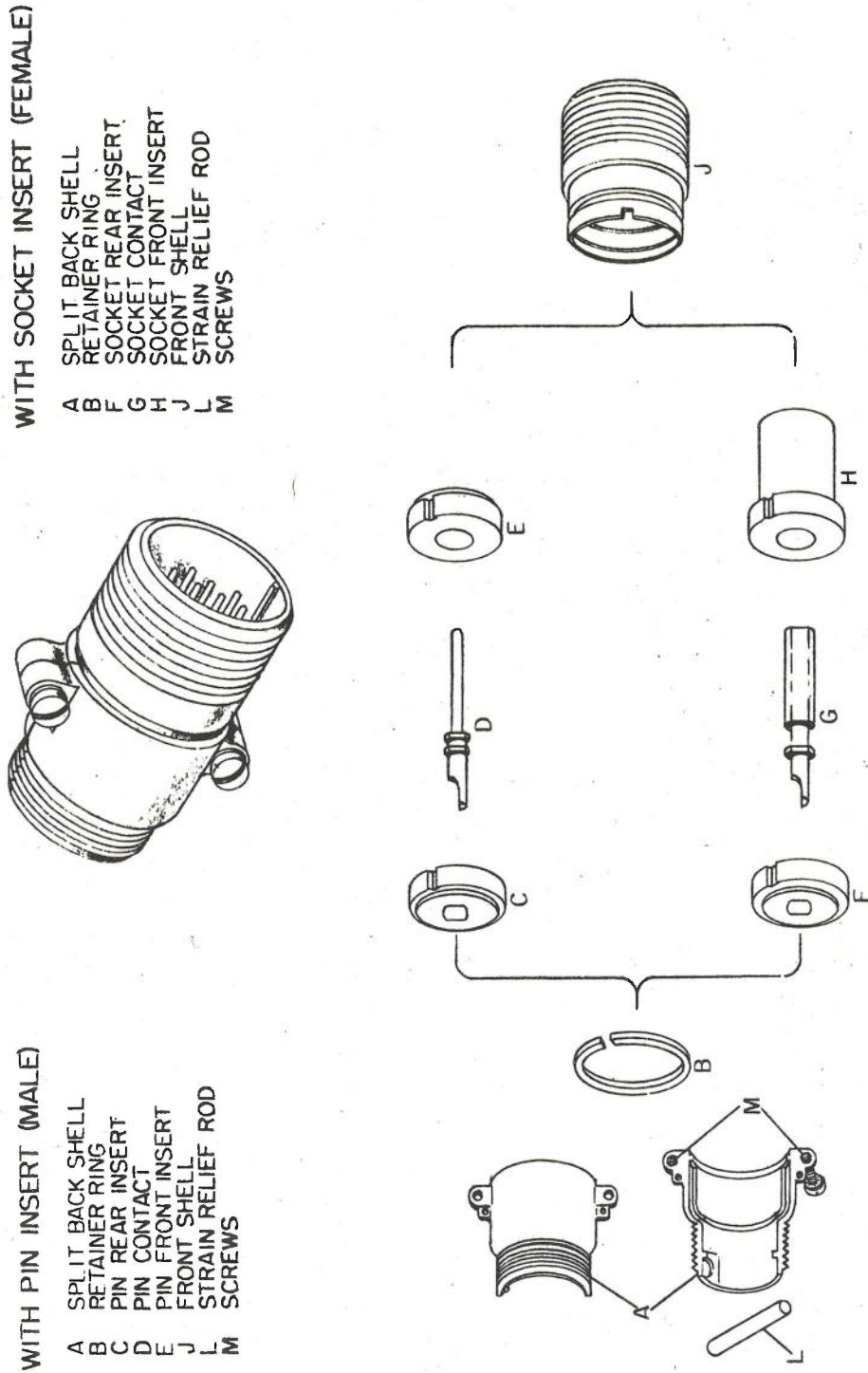

Figure 5-59. Amphenol AN3101A Solid Shell Cable Receptacle



WITH SOCKET INSERT (FEMALE)

- A SPLIT BACK SHELL
- B RETAINER RING
- C SOCKET REAR INSERT
- D SOCKET CONTACT
- E SOCKET FRONT INSERT
- J FRONT SHELL
- L STRAIN RELIEF ROD
- M SCREWS

WITH PIN INSERT (MALE)

- A SPLIT BACK SHELL
- B RETAINER RING
- C PIN REAR INSERT
- D PIN CONTACT
- E PIN FRONT INSERT
- J FRONT SHELL
- L STRAIN RELIEF ROD
- M SCREWS

Figure 5-60. Amphenol An 3101B Split Shell Cable Receptacle

WITH SOCKET INSERT (FEMALE)

- B RETAINER RING
- F SOCKET REAR INSERT
- G SOCKET CONTACT
- H SOCKET FRONT INSERT
- J FRONT SHELL

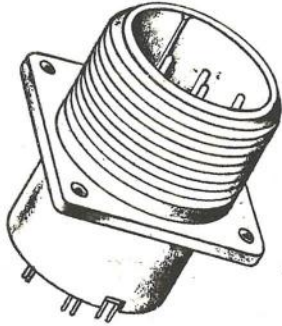

WITH PIN INSERT (MALE)

- B RETAINER RING
- C PIN REAR INSERT
- D PIN CONTACT
- E PIN FRONT INSERT
- J FRONT SHELL

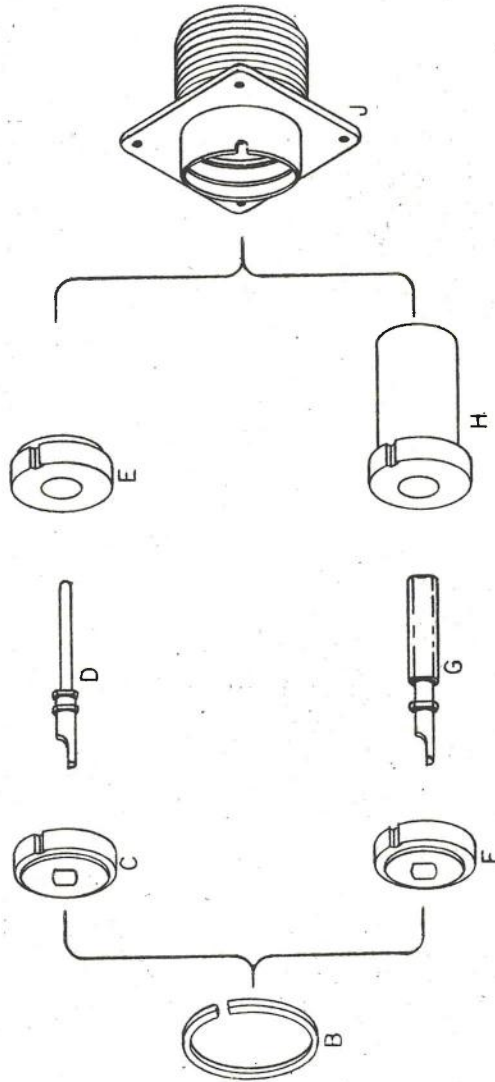

Figure 5-61. Amphenol AN 3102A Solid Shell Box Receptacle

WITH SOCKET INSERT (FEMALE)

- A BACK SHELL
- B RETAINER RING
- F SOCKET REAR INSERT
- G SOCKET CONTACT
- H SOCKET FRONT INSERT
- J FRONT SHELL
- K COUPLING RING



WITH PIN INSERT (MALE)

- A BACK SHELL
- B RETAINER RING
- C PIN REAR INSERT
- D PIN CONTACT
- E PIN FRONT INSERT
- J FRONT SHELL
- K COUPLING RING

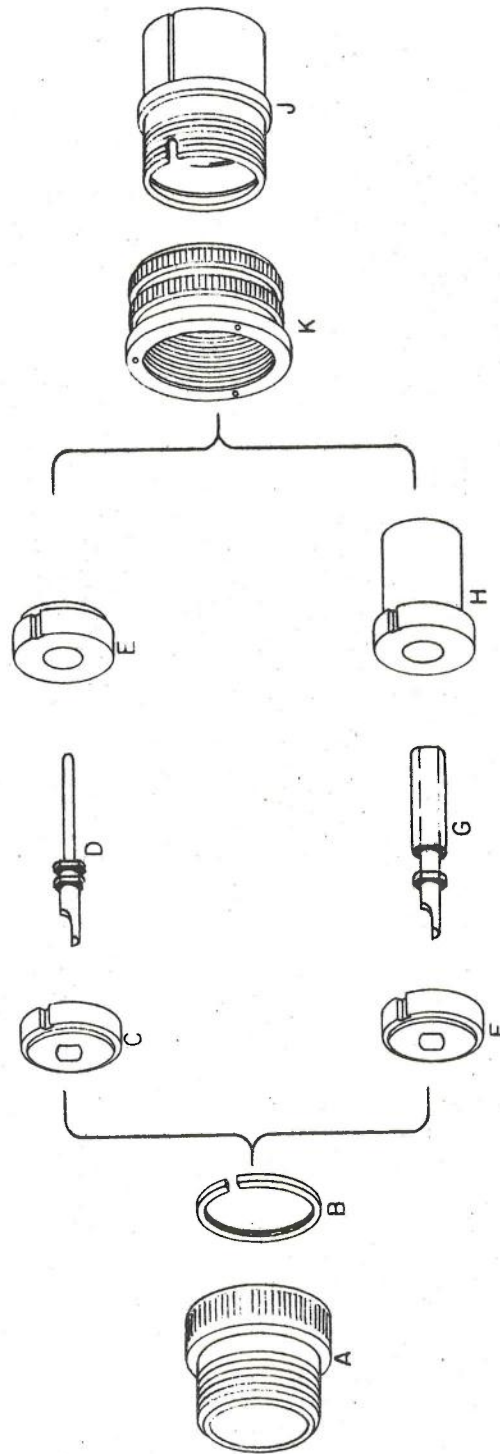
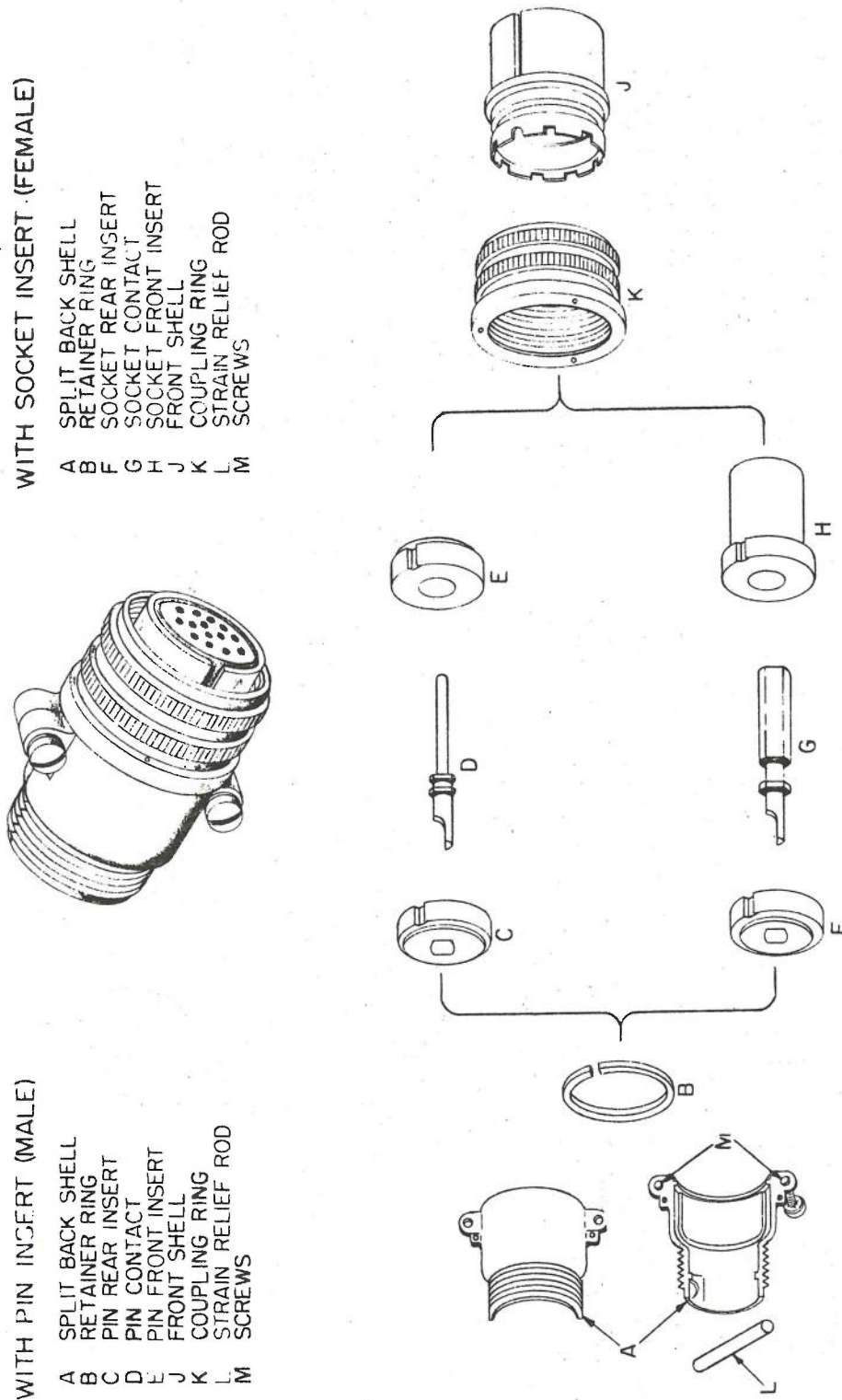

Figure 5-62. Amphenol AN 3106A Solid Shell Straight Plug



WITH PIN INSERT (MALE)

- A SPLIT BACK SHELL
- B RETAINER RING
- C PIN REAR INSERT
- D PIN FRONT INSERT
- E PIN FRONT SHELL
- F COUPLING RING
- G STRAIN RELIEF ROD
- H SCREWS

WITH SOCKET INSERT (FEMALE)

- A SPLIT BACK SHELL
- B RETAINER RING
- C SOCKET REAR INSERT
- D SOCKET FRONT INSERT
- E FRONT SHELL
- F COUPLING RING
- G STRAIN RELIEF ROD
- H SCREWS

Figure 5-63. Amphenol AN 3106B Split Shell Straight Plug

WITH PIN INSERT (MALE)

- A RETAINER RING
- B CERAMIC BACKING DISC
- C SILICONE RUBBER GASKET
- D PIN CONTACT (MALE)
- E CERAMIC PIN INSULATION
- K SHELL AND COUPLING RING ASSY

WITH SOCKET INSERT (FEMALE)

- A RETAINER RING
- F CERAMIC BACKING DISC
- G SILICONE RUBBER GASKET
- H SOCKET CONTACT (FEMALE)
- J CERAMIC SOCKET INSULATION
- K SHELL AND COUPLING RING ASSY

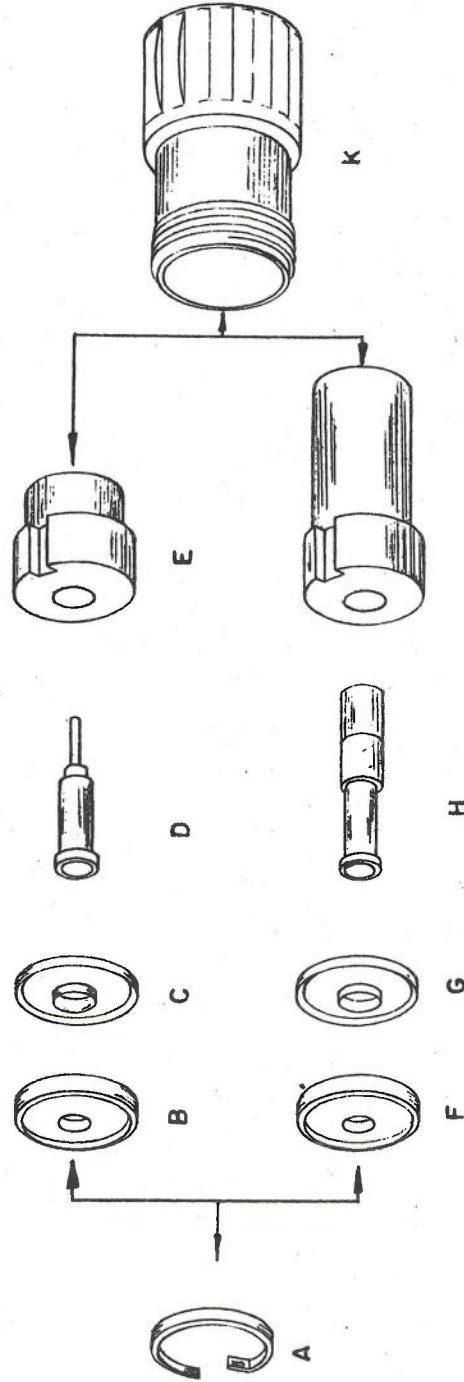
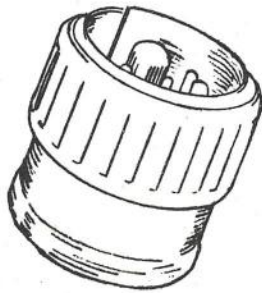
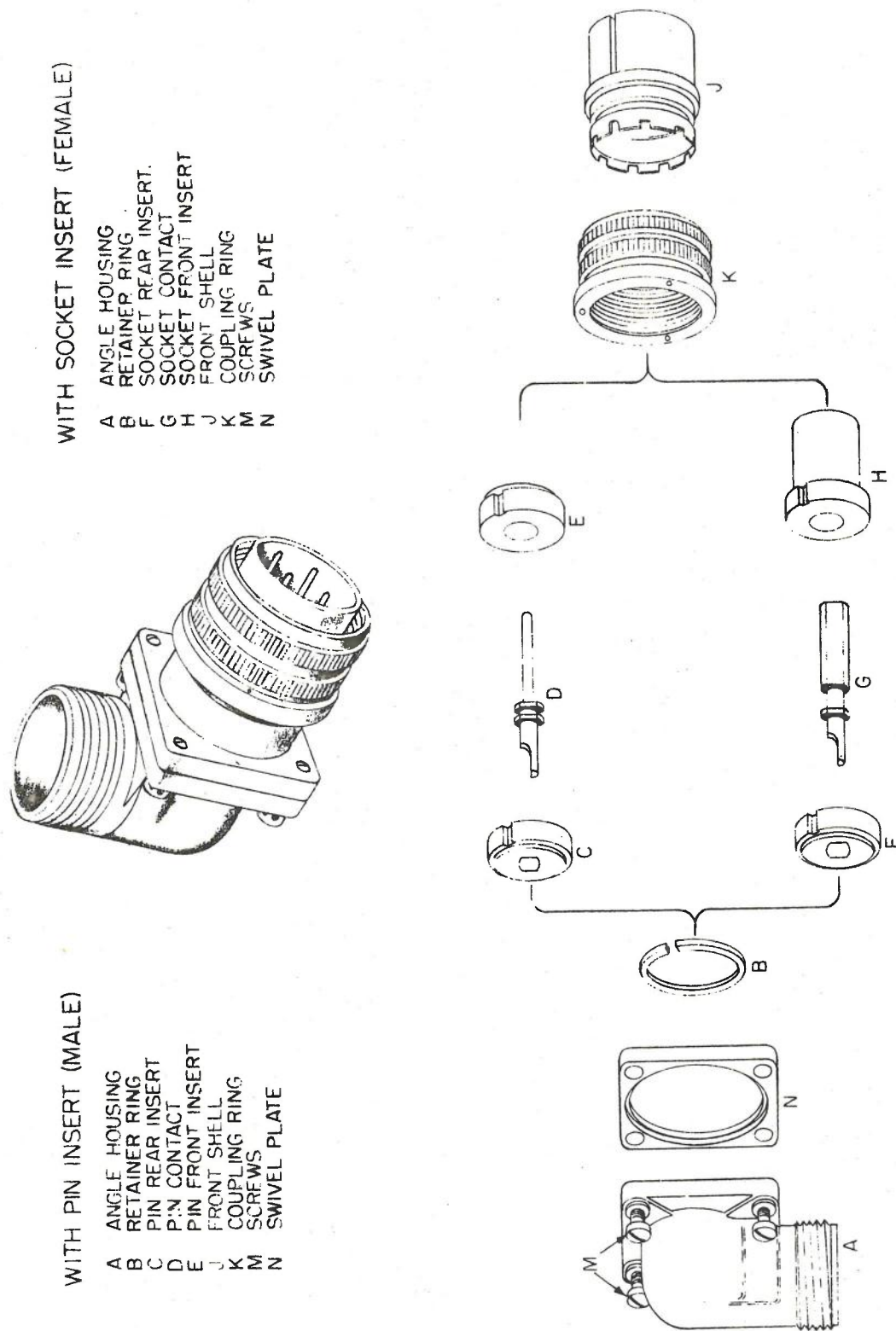

Figure 5-64. Amphenol AN 3106K Straight Plug



WITH PIN INSERT (MALE)

- A ANGLE HOUSING
- B RETAINER RING
- C PIN REAR INSERT
- D PIN CONTACT
- E PIN FRONT INSERT
- J FRONT SHELL
- K COUPLING RING
- M SCREWS
- N SWIVEL PLATE

WITH SOCKET INSERT (FEMALE)

- A ANGLE HOUSING
- B RETAINER RING
- F SOCKET REAR INSERT
- G SOCKET CONTACT
- H FRONT SHELL
- J COUPLING RING
- K SCREWS
- N SWIVEL PLATE

Figure 5-65. Amphenol AN 3108A Solid Shell Angle Plug

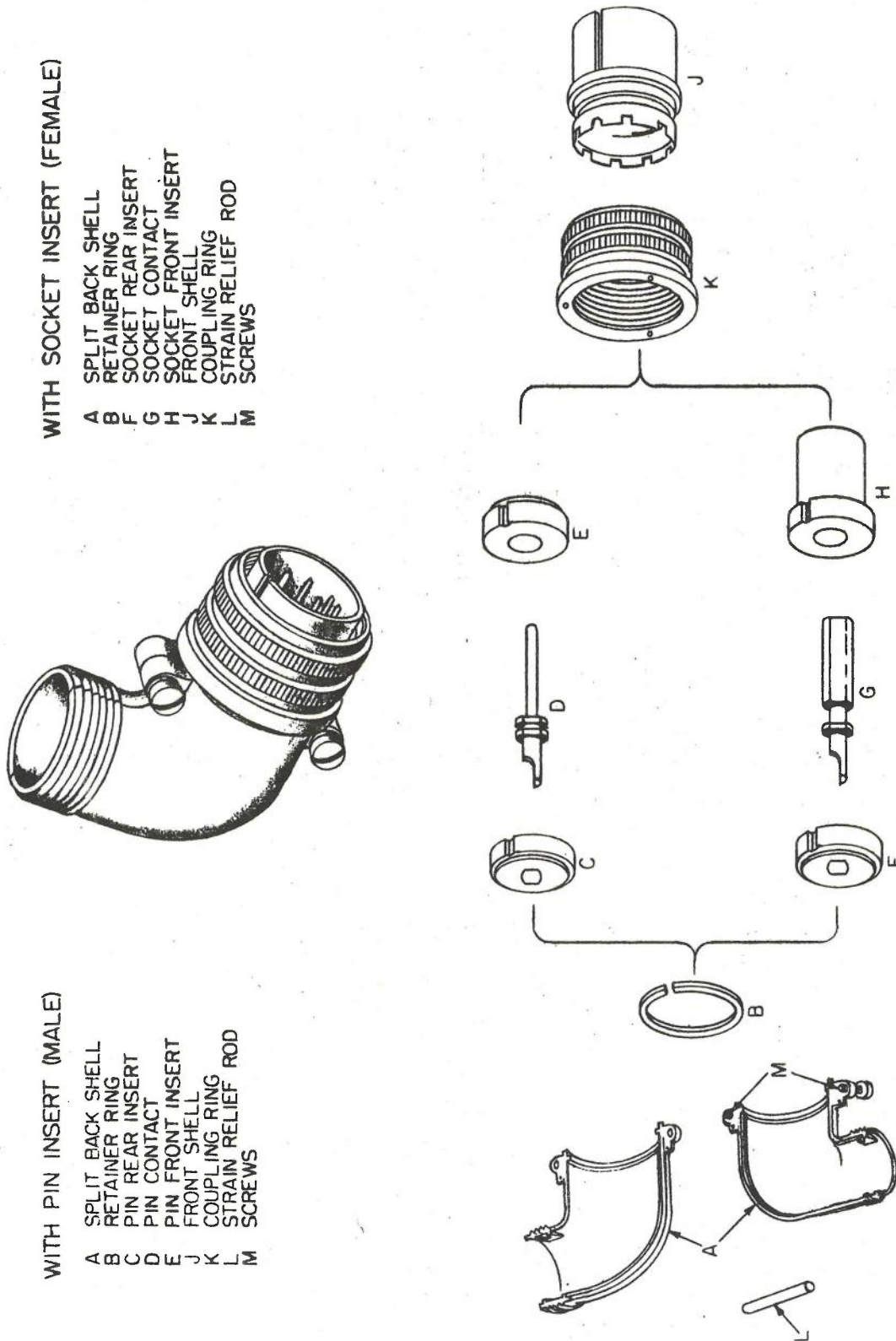

WITH SOCKET INSERT (FEMALE)

- A SPLIT BACK SHELL
- B RETAINER RING
- F SOCKET REAR INSERT
- G SOCKET CONTACT
- H SOCKET FRONT INSERT
- J FRONT SHELL
- K COUPLING RING
- L STRAIN RELIEF ROD
- M SCREWS

WITH PIN INSERT (MALE)

- A SPLIT BACK SHELL
- B RETAINER RING
- C PIN REAR INSERT
- D PIN CONTACT
- E PIN FRONT INSERT
- F FRONT SHELL
- G COUPLING RING
- H STRAIN RELIEF ROD
- I SCREWS

Figure 5-66. Amphenol AN 3108B Split Shell Angle Plug

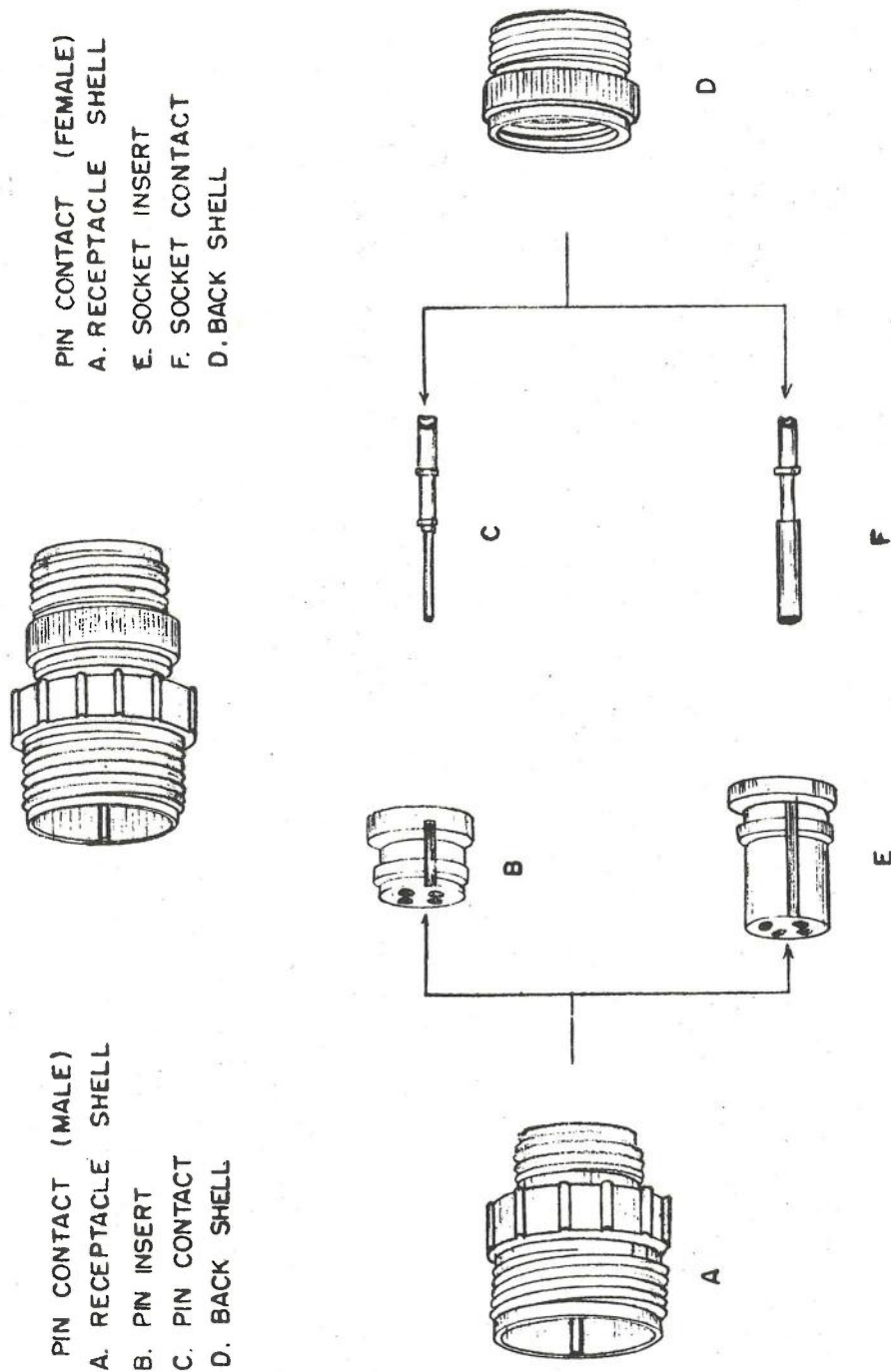

PIN CONTACT (FEMALE)
A. RECEPTACLE SHELL
E. SOCKET INSERT
F. SOCKET CONTACT
D. BACK SHELL

PIN CONTACT (MALE)
A. RECEPTACLE SHELL
B. PIN INSERT
C. PIN CONTACT
D. BACK SHELL

Figure 5-67. Bendix AN 3101A Cable Connecting Assembly

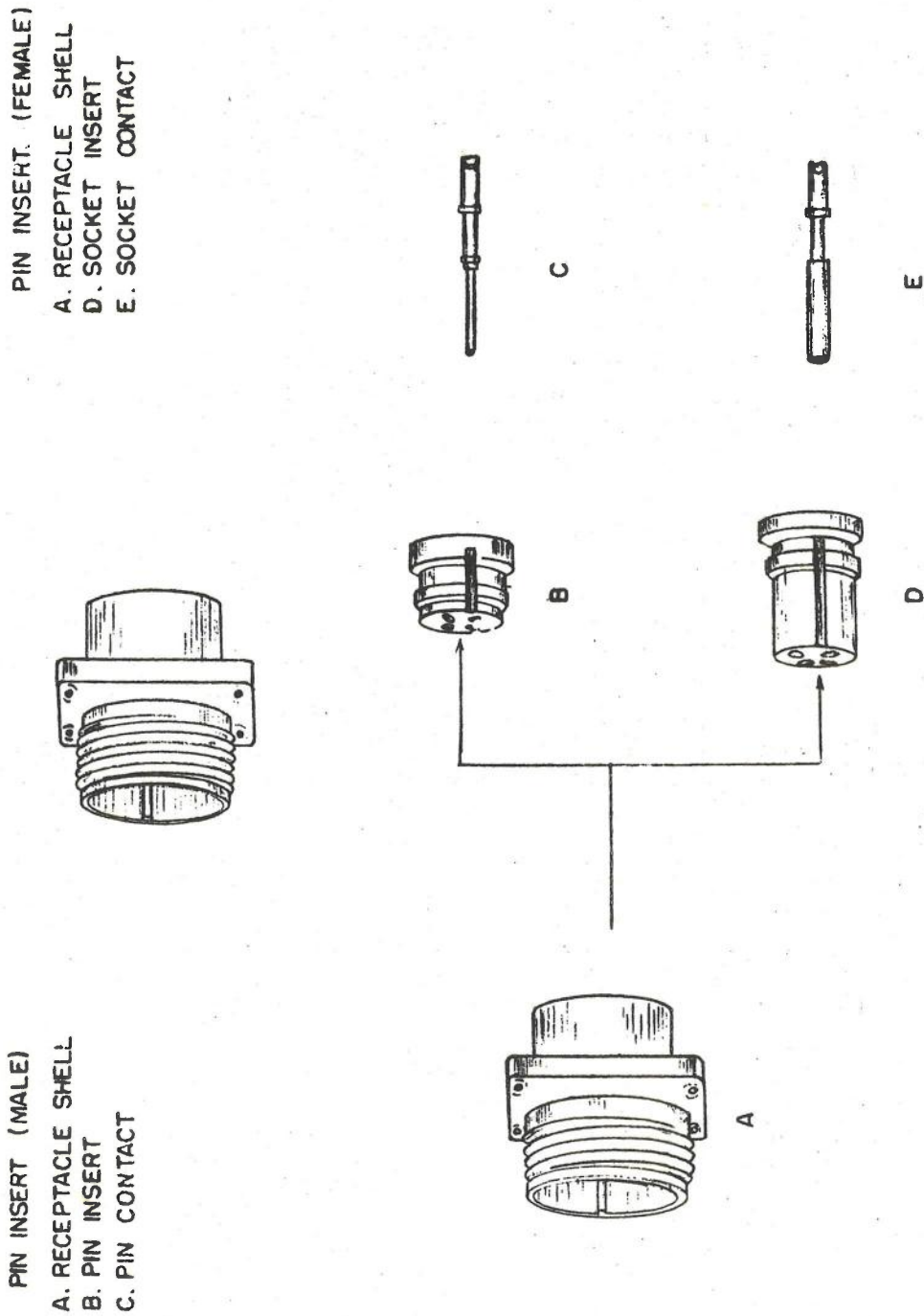

Figure 5-68. Bendix AN 3102A Box Mounting Receptacle Assembly

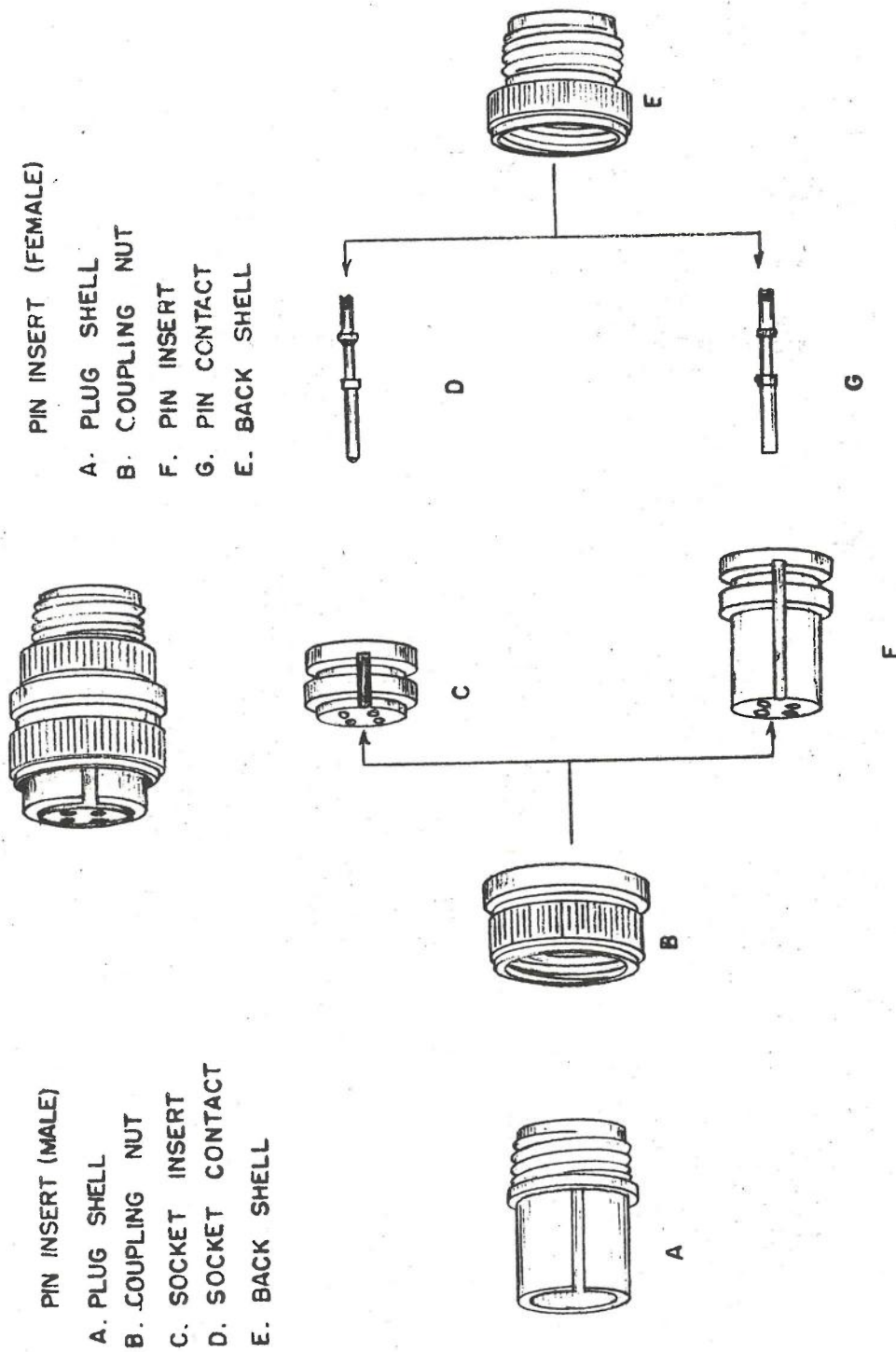
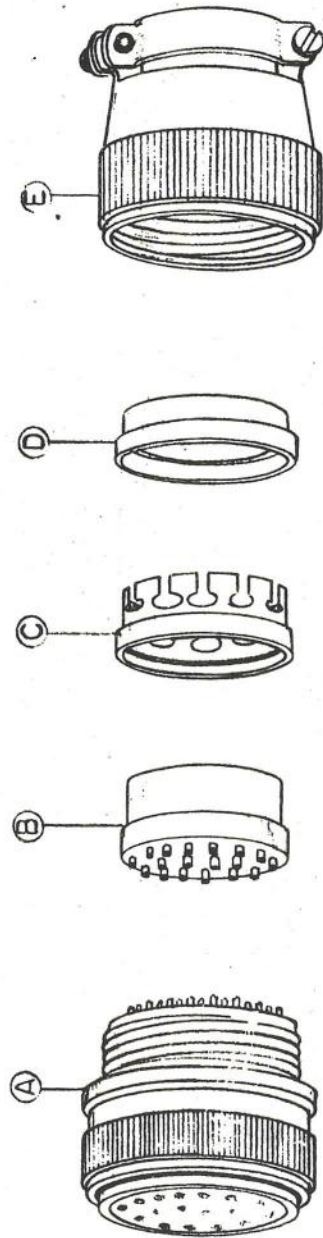
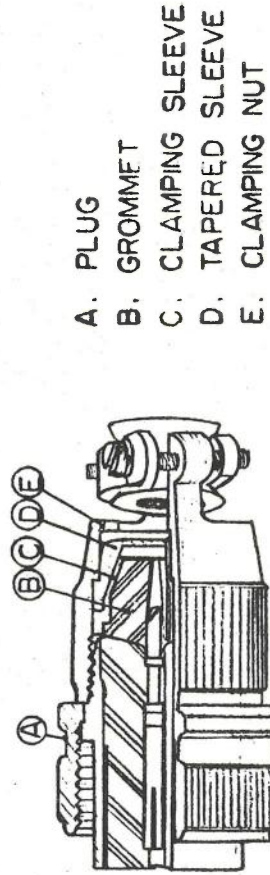

Figure 5-69. Bendix AN 3106A Straight Plug Assembly



PARTS ASSEMBLY



CUTAWAY VIEW

Figure 5-70. Bendix AN 3106M Type M Connector

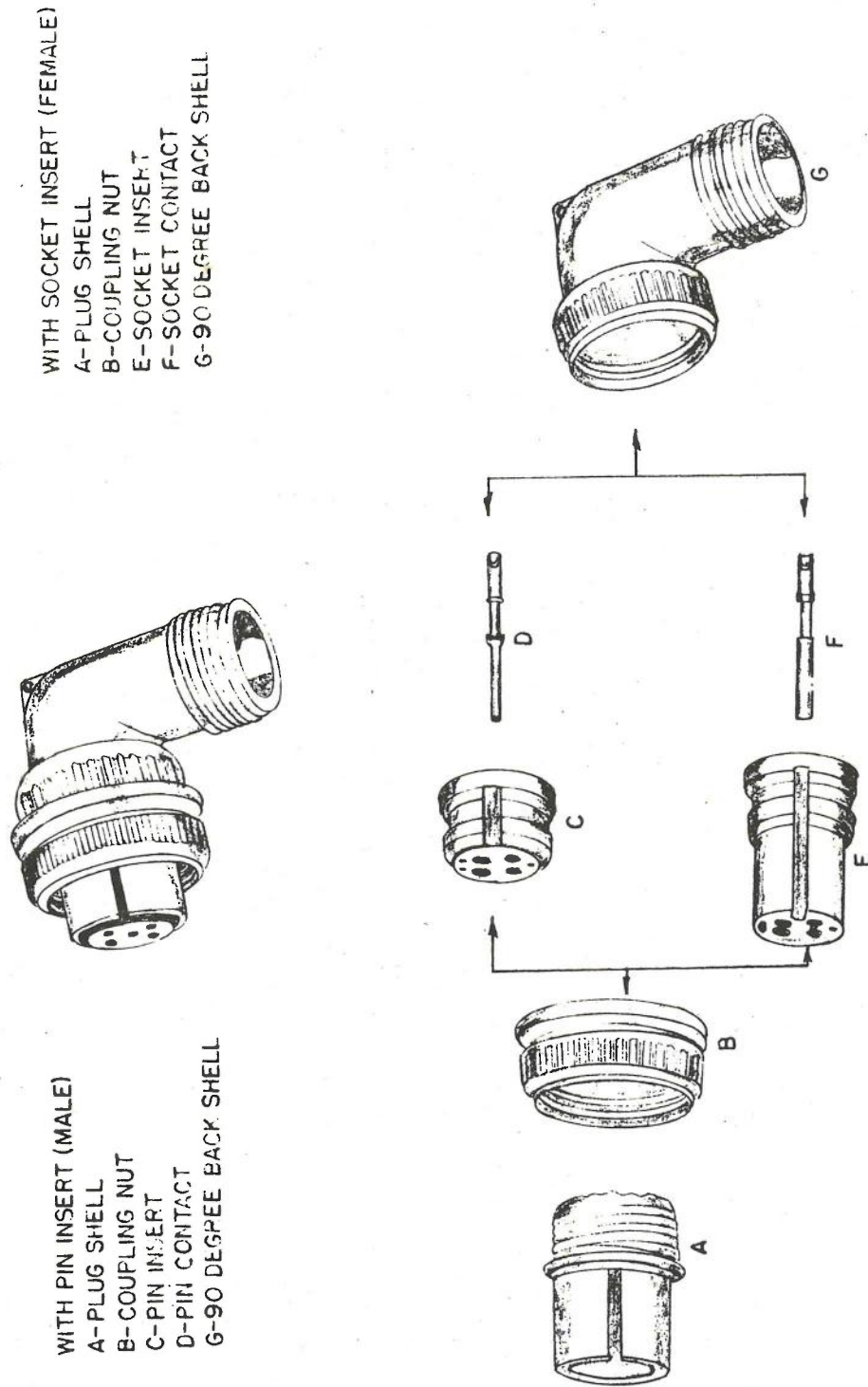

Figure 5-71. Bendix AN 3108A 90-Degree Plug Assembly

INDEX

Subject -A-	Figure or Table No.	Page
Alternate method of grounding armor at "AN" connectors	5-53	5-54
Alternate position inserts	5-43	5-45
Amphenol AN connectors	5-11	5-12
AN 3057 cable clamp data, table of	5-8	5-52
AN 3100 types	5-15
AN 3100A solid shell wall receptacle	5-56	5-58
AN 3100B split shell wall receptacle	5-57	5-59
AN 3100K shielded receptacle	5-58	5-60
AN 3101 types	5-15
AN 3101A cable connecting assembly	5-67	5-69
AN 3101A solid shell cable receptacle	5-59	5-61
AN 3101B split shell cable receptacle	5-60	5-62
AN 3102 types	5-16
AN 3102A box mounting receptacle assembly	5-68	5-70
AN 3102A solid shell box receptacle	5-61	5-63
AN 3106 types	5-16
AN 3106A solid shell straight plug	5-62	5-64
AN 3106A straight plug assembly	5-69	5-71
AN 3106B split shell straight plug	5-63	5-65
AN 3106K straight plug	5-64	5-66
AN 3106M type M connector	5-70	5-72
AN 3107 types	5-16
AN 3108 types	5-16
AN 3108A plug assembly, 90 degree	5-71	5-73
AN 3108A solid shell angle plug	5-65	5-67
AN 3108A split shell angle plug	5-66	5-68
AN connectors	5-1
Amphenol	5-11
Bendix	5-15
Cannon	5-15
AN designation from MIL-C-5015	5-22	5-18
AN insert contact arrangements	5-20
1 contact	5-23	5-20
2 contact	5-24	5-21
3 contact	5-25	5-22
4 contact	5-26	5-23
5 contact	5-27	5-24
6 contact	5-28	5-25
7 contact	5-29	5-26
8 contact	5-30	5-27
9 contact	5-31	5-28
10 and 11 contact	5-32	5-29
12 and 13 contact	5-33	5-30
14 contact	5-34	5-31
15 and 16 contact	5-35	5-32

Subject -A-	Figure or Table No.	Page
AN insert contact arrangements (cont'd)		
17, 19 and 20 contact	5-36	5-33
22 and 23 contact	5-37	5-34
24, 25 and 26 contact	5-38	5-35
29 and 30 contact	5-39	5-36
31 and 35 contact	5-40	5-37
37, 41 and 42 contact	5-41	5-38
47 and 48 contact	5-42	5-38
AND 10066 types	5-16
AND 10459 types	5-17
Automatic grounding and short-circuiting connectors	5-44	5-46
-B-		
Basic design of amphenol AN connectors	5-11	5-12
Basic design of AN connectors	5-11
Contact	5-11
Insert	5-11
Polarization	5-11
Receptacle	5-11
Shell	5-11
Bendix AN connectors	5-13	5-14
Bendix basic design	5-15
Bendix box mounting receptacle assembly, AN 3102A	5-68	5-70
Bendix cable connecting assembly, AN 3101A	5-67	5-69
Bendix 90-degree plug assembly, AN 3108A	5-71	5-73
Bendix straight plug assembly, AN 3106A	5-69	5-71
Bendix type M connector, AN 3106M	5-70	5-72
Box mounting receptacle	5-16	5-16
Box mounting receptacle assembly, AN 3102A	5-68	5-70
-C-		
Cable connecting assembly, AN 3101A	5-67	5-69
Cable mounting receptacle	5-15	5-15
Cannon AN connectors	5-12	5-13
Cannon basic design	5-15
Choosing the shell style	5-39
Choosing the terminal size	5-5
Clamp for unarmored cable	5-55
Connecting and soldering	5-5
Connecting at screw terminals	5-10
Connecting at terminal boards	5-10
General	5-5
Preparation of conductors for soldering	5-5
Soldering	5-8
Soldering notched or blank hook terminals	5-9
Soldering perforated terminals	5-9
Soldering tubular terminals	5-9
The soldering iron	5-8
Connecting at screw terminals	5-10

Subject -C-	Figure or Table No.	Page
Connecting at terminal boards	5-10
Connect designation	5-18
Connector part number	5-39
Contact	5-11
Pin	5-11
Socket	5-11
Contact type	5-39
Coupling thread size for various AN shell sizes, table of	5-9	5-57
Current rating	5-19
-E-		
Electrical connectors size designation, table of	5-2	5-6
Enamel covered wire	5-7
Enamel removing tool made from old hacksaw blade	5-5	5-7
-G-		
General, connecting and soldering	5-5
General installation hints	5-56
General, solderless terminals	5-10
-I-		
Insert	5-11
Insert selection	5-39
Insert selection example	5-19
Insert specifications (8S-1 to 18-19), table of	5-3	5-39
Insert specifications (18-20 to 22-15), table of	5-4	5-40
Insert specifications (22-16 to 24-28), table of	5-5	5-42
Insert specifications (28-1 to 32-12), table of	5-6	5-43
Insert specifications (32-13 to 48-1), table of	5-7	5-44
Inserts available	5-19
Inserts required	5-19
Contact type	5-39
Current rating	5-19
Insert selection	5-19
Inserts available	5-19
Voltage rating	5-19
Installation	5-47
Clamp for unarmored cables	5-55
General installation hints	5-56
Method of terminating armored cable and shields at "AN" connectors	5-52
Safety wiring	5-56
Soldering to the connectors	5-47
Strain relief bar	5-51
Integral mounting plug	5-21	5-17
Integral mounting receptacle	5-17	5-16
Introduction, AN connectors	5-11
Introduction, solder terminals	5-1

Subject -J-	Figure or Table No.	Page
Jones plug and socket assembly	5-45	5-47
Jones plugs and sockets	5-47
-L-		
Litz wire	5-8
-M-		
Method of terminating armored cable and shields at "AN" connectors	5-52
-P-		
Perforated, notched and miscellaneous type terminals	5-2	5-3
Pin contact	5-11
Plug, basic design	5-11
Polarization, basic design	5-11
Position of locking ring	5-50	5-51
Preparation of conductors for soldering	5-7
Enamel covered wire	5-7
Litz wire	5-7
Stranded wire	5-7
Tinsel wire	5-7
Pre-tinning conductors	5-46	5-48
-R-		
Receptacle	5-11
Right angle plug	5-20	5-17
-S-		
Safety wiring	5-56
Selecting the proper connector	5-19
Shell	5-11
Shell design	5-17
Shielded receptacle, AN 3100K	5-58	5-60
Socket	5-11
Solder and lug terminal-punched tube type, table of	5-1	5-4
Solder terminals	5-1
Soldering	5-8
Soldering cables to contacts	5-43	5-49
Soldering iron tip shapes	5-6	5-7
Soldering notched or blank hook terminals	5-9	5-9
Soldering perforated terminals	5-8	5-9
Soldering to large removable contacts	5-49	5-50
Soldering to the connectors	5-47
Solderless terminal types	5-10
WT and WTG	5-10	5-10
Solderless terminals	5-1

Subject -S-	Figure or Table No.	Page
Solid shell angle plug, AN 3108A	5-65	5-67
Solid shell box receptacle, AN 3102A	5-61	5-63
Solid shell cable receptacle, AN 3101A	5-59	5-61
Solid shell straight plug, AN 3106A	5-62	5-64
Solid shell wall receptacle, AN 3100A	5-56	5-58
Spade lugs and grid caps	5-3	5-5
Special connector notes	5-45
Alternate position inserts	5-45
Automatic grounding and short-circuiting connectors	5-46
Jones plugs and sockets	5-47
Thermocouple connectors	5-46
Split shell angle plug, AN 3108A	5-66	5-68
Split shell cable receptacle, AN 3101B	5-60	5-62
Split shell straight plug, AN 3106B	5-63	5-65
Split shell wall receptacle, AN 3100B	5-57	5-59
Stamped type solder lug terminals	5-1	5-2
Straight plug	5-18	5-16
Straight plug, AN 3106K	5-64	5-66
Straight plug, assembly, AN 3106A	5-69	5-71
Straight quick-disconnect plug	5-19	5-16
Strain relief bar	5-51	5-51
Stranded wire	5-8
Strap wrench	5-55	5-56
-T-		
Terminal designation	5-5
Terminating cable armor at "AN" connectors	5-52	5-53
Terminating tinsel wire	5-6	5-8
Thermocouple connectors	5-46
The soldering iron	5-5
Tieing conductors with string	5-48	5-50
Tinsel wire	5-8
Type M connector, AN 3106M	5-70	5-72
Types impregnated with silicone	5-8
Types of AN connectors	5-15
AN 3100	5-15
AN 3101	5-16
AN 3102	5-16
AN 3106	5-16
AN 3107	5-16
AN 3108	5-16
AND 10066	5-16
AND 10459	5-17
-U-		
Use of cable clamp AN 3057	5-54	5-55
-V-		
Voltage rating of inserts required	5-19

Subject -W-	Figure or Table No.	Page
Wall mounting receptacle.....	5-14	5-15
WT and WTG solderless terminal types.....	5-10	5-10

